











## MERCEDES-BENZ

### WATER PUMP / WASSERPUMPEN

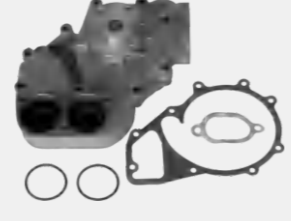
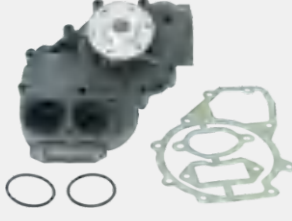
	ENGINE	OE NUMBER		ENGINE	OE NUMBER
	OM 355/A	355 200 0801 345 200 0901 355 200 1501 355 200 1101 355 200 0901 355 200 0501 355 200 0801 355 200 0601 355 200 0101		OM 314	314 200 4701 314 200 4101
	OM 314	314 200 4201 314 200 3901 314 200 3701 314 200 2901 314 200 2401 314 200 1901 314 200 0801		OM 364/A/LA	364 200 2001 364 200 0101 364 200 0901
	OM 355 /A	355 200 0801 345 200 0901 355 200 1501 355 200 1101 355 200 0901 355 200 0501 355 200 0801 355 200 0601 355 200 0101		OM 366/A/LA	366 200 5901 366 200 0901 366 200 0401 366 200 0701 376 200 0701
	OM 366 /A/LA	366 200 5901 366 200 0901 366 200 0401 366 200 0701 376 200 0701		OM 442 OM 447	422 200 1201 422 200 0701 442 200 1201
	OM 401 OM 402 OM 403 OM 407 OM 421 OM 422 OM 423 OM 424 OM 427 OM 441 OM 442 OM 443 OM 444 OM 427	422 200 1101 422 200 0601 422 200 1601 422 200 1801		OM 422/442 OM 423/443 OM 404/444	422 200 1001 422 200 0501 403 200 5701

	ENGINE	OE NUMBER		ENGINE	OE NUMBER
	OM 501 LA OM 502 LA	542 200 2001 542 200 1601 542 200 0601		OM 407-409 OM 427-429 A/H/LA OM 447-449 A/H/LA	422 200 0201
	OM501LA OM502LA	542 200 0104 542 200 0004		WITH METAL GASKET	542 200 0104
	OM 401-404/ A/LA OM 421-424/ A/LA OM 441-444/ A/LA	422 200 0604 422 200 0104 422 200 0304 422 200 0104 422 200 0120 423 200 0104		OM 401-404 OM 401 LA OM 402 LA OM 407 /A/hA/h OM 409 OM 421-424 / A/LA OM 427-429 OM 441-444 / A/LA OM 447-449	403 200 7101 403 200 5101 403 200 4401 403 200 3601 403 200 0601
	Famsa L6 OM366 Turbocargado L6 con Post enfriador (1979-92) Autobus OF-1318/5, OF-1318/U, OF-1418/51Fam sa L6 OM366	390 200 0101		OM 401-404 OM 407 /A/hA/h OM 409	403 200 7001 403 200 4901 403 200 3501 403 200 2701 403 200 3201 403 200 3401
	OM 407 H OM 422 OM 427 H/HA OM 441 OM 447 HA	403 200 7301 403 200 5301		OM 401-404 OM 401 LA OM 402 LA OM 407/A/hA/h OM 409 OM 421-424/ A/LA OM 427-429 OM 441-444/ A/LA OM 447-449	403 200 7601 403 200 7701

## WATER PUMP / WASSERPUMPEN

	ENGINE	OE NUMBER		ENGINE	OE NUMBER
	OM 441/442/ A/LA	441 200 0201 441 200 0101		OM 501 LA OM 502 LA	542 200 1901 542 200 1501 542 200 0501
	OM 501 LA OM 502 LA	541 200 1201 541 200 1101 541 200 0101 541 200 0701 541 200 1901		OM 904/906LA	904 200 4901 904 200 2601 904 200 2001 904 200 0801 904 200 0401 904 200 4301 904 200 2201 904 200 2501 904 200 1901 904 200 0701 904 200 0601 904 200 0201 904 200 3801 904 200 3201
	OM 457 OM 458	457 200 0501 457 200 0201 457 200 2501 457 200 1101 457 200 2701 457 200 7001		OM 366	366 200 6801 366 200 0001 366 200 0901 366 200 6701 366 200 5501 366 200 5401
	OM 366	366 200 6801X		OM 441 OM 442	441 200 0104 441 200 0204
	OM 355	355 200 1204 355 200 0804		OM 366 OM 366 A OM 366 LA OM 366 LA Euro II	366 200 0804 366 200 0604 366 200 0304 366 200 0004

## WATER PUMP / WASSERPUMPEN

ENGINE	OE NUMBER	ENGINE	OE NUMBER
OM 904/906 LA	904 200 0004 906 200 0004	OM 314	314 200 1004 314 200 0704
OM 364/A/ LA	364 200 0804 364 200 0504 364 200 0304	OM501 LA OM502 LA	541 200 0004
OM 364 OM 352	353 200 0401 353 200 3601 353 200 0301 352 200 3801 352 200 7401 352 200 8401 352 200 9401	OM 904 LA OM 906 LA	906 200 5401 906 200 2901 906 200 2201 906 200 1401 906 200 4801 906 200 6501
OM 364 OM 352	353 200 5601 352 200 9501 352 200 9701 353 200 1701	without cover	353 2005 601x
OM 352	353 200 2101 353 200 3701	OM 352	352 200 4404 352 200 4304

## WATER PUMP / WASSERPUMPEN

ENGINE	OE NUMBER	ENGINE	OE NUMBER
OM 352	352 200 3804	OM 352	352 200 4104 352 200 4504
OM 501 LA OM 502 LA	542 200 2301 541 200 0901	OM 501 LA OM 502 LA	542 200 2401
OM 637 OM 637	376 200 0001 376 200 0401 376 200 0501 376 200 0601	OM 355 OM 355/A	355 200 1304 355 200 0904 355 200 0404
OM 457 OM 458	457 200 0801 457 200 2301 457 200 2901	OM 457 OM 458	457 200 0004 457 200 0104 457 200 0104
OM 457/LA	457 200 0101 457 200 2401 457 200 0901	OM 904LA OM 906LA	906 200 2801 906 200 6201 906 200 3701 906 200 5501

## WATER PUMP / WASSERPUMPEN

	ENGINE	OE NUMBER		ENGINE	OE NUMBER
	OM 457 OM 458	457 200 1001 457 200 2401 457 200 0901		OM 401/A OM 402/A OM 403 OM 407AH/LA OM 421/A/LA OM 422/A/LA OM 423/A/LA OM 424/A/LA OM 427AH/LA OM 442/A/LA OM 443 OM 447/A/AH/ LA	422 200 1401
	OM 423	403 200 7501		Actros	542 200 2201 542 200 1801
	Actros	542 200 2101 542 200 1701		Actros	REPAIR KIT FOR 542 200 2101 542 200 2201 VS-ME156 VS-ME157
	OM 457LA OM 460LA	460 200 0001		OM 904 LA OM 906 LA	906 200 6101 906 200 6401 906 200 5801
	OM 350+A	353 200 4001		OM906 HLA	906 200 6001 906 200 5201 906 200 2601







## WATER PUMP / WASSERPUMPEN

	ENGINE	OE NUMBER		ENGINE	OE NUMBER
	OM906 LA OM924 LA OM926 LA	906 200 4001 906 200 5101 906 200 4301 906 200 6301		OM906 LA OM924 LA OM926 LA	
	OM 906LA OM 924LA OM 926LA	906 200 4001 906 200 5101 906 200 4301 906 200 6301		OM 904LA OM 906LA OM 924LA OM 926LA	906 200 6201 906 200 4901
	ME111 HOUSING+ ME138 COVER			ME123 HOUSING+ 115MM IMPELLER	
	OM 906LA OM 924LA OM 926LA	9062004001 9062005101 9062004301		Actros	541 200 2801
	HUB 114mm	904 200 4901		ME128 HOUSING+ 141.5MM PULLEY	

## WATER PUMP / WASSERPUMPEN

	ENGINE	OE NUMBER		ENGINE	OE NUMBER
	OM 904LA OM 906LA OM 924LA OM 926LA	904 200 5101 904 200 4701		OM 501LA OM 502LA	541 200 1401 541 200 0801
	OM 541	541 200 2001 541 200 2301		OM 934 OM 936 IMPELLER 99MM	936 200 1601
	OM 470LA OM 471LA	470 200 0201		Actors	541 200 2701 541 200 1801
	OM 934 OM 936 IMPELLER 88MM	936 200 1501 936 200 0801		OM 934 OM 936 IMPELLER 101MM	936 200 1701 936 200 1301 936 200 0601
	OM 346 A OM 355/A	355 180 0101		OM 352 /A OM 362 LA OM 366 A/LA	366 180 0401 366 180 0101 366 180 7701 366 180 7501

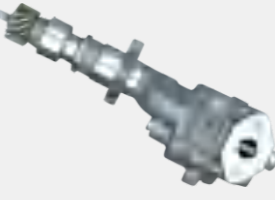
## WATER PUMP / WASSERPUMPEN

	ENGINE	OE NUMBER		ENGINE	OE NUMBER
	OM 401A OM 402 OM 403 OM 407/A/H/ HA/LA OM 401A/L OM 402A/L OM 407/A OM 401A/L OM 402 OM 407/A	403 180 1701 403 180 0001 403 180 0101 403 180 0201 403 180 0601 403 180 3301		OM 407 AH OM 427 H/HA OM 447 H/HA	403 180 2801
	OM 402LA OM 403 OM 422A/LA OM 423 OM 442A/LA	423 180 2501 423 180 2301 423 180 0501 423 180 0101		OM 501 LA	541 180 0301 541 180 2301 541 180 0101 541 180 0001
	OM 502	542 180 0101 542 180 0201 542 180 0001 542 180 0701		OM 352+A	352 180 6301 314 180 2601 314 180 1001 314 180 0501
	OM 314/A OM 352/A/H OM 352/A/LA OM 366	364 180 0101 314 180 2401 352 180 0201 352 180 7001		OM 407/H OM 407/AH OM 427 OM 447H OM 447HA OM 447HLA OM 449HLA OM 447HG	403 180 2701

# WATER PUMP / WASSERPUMPEN

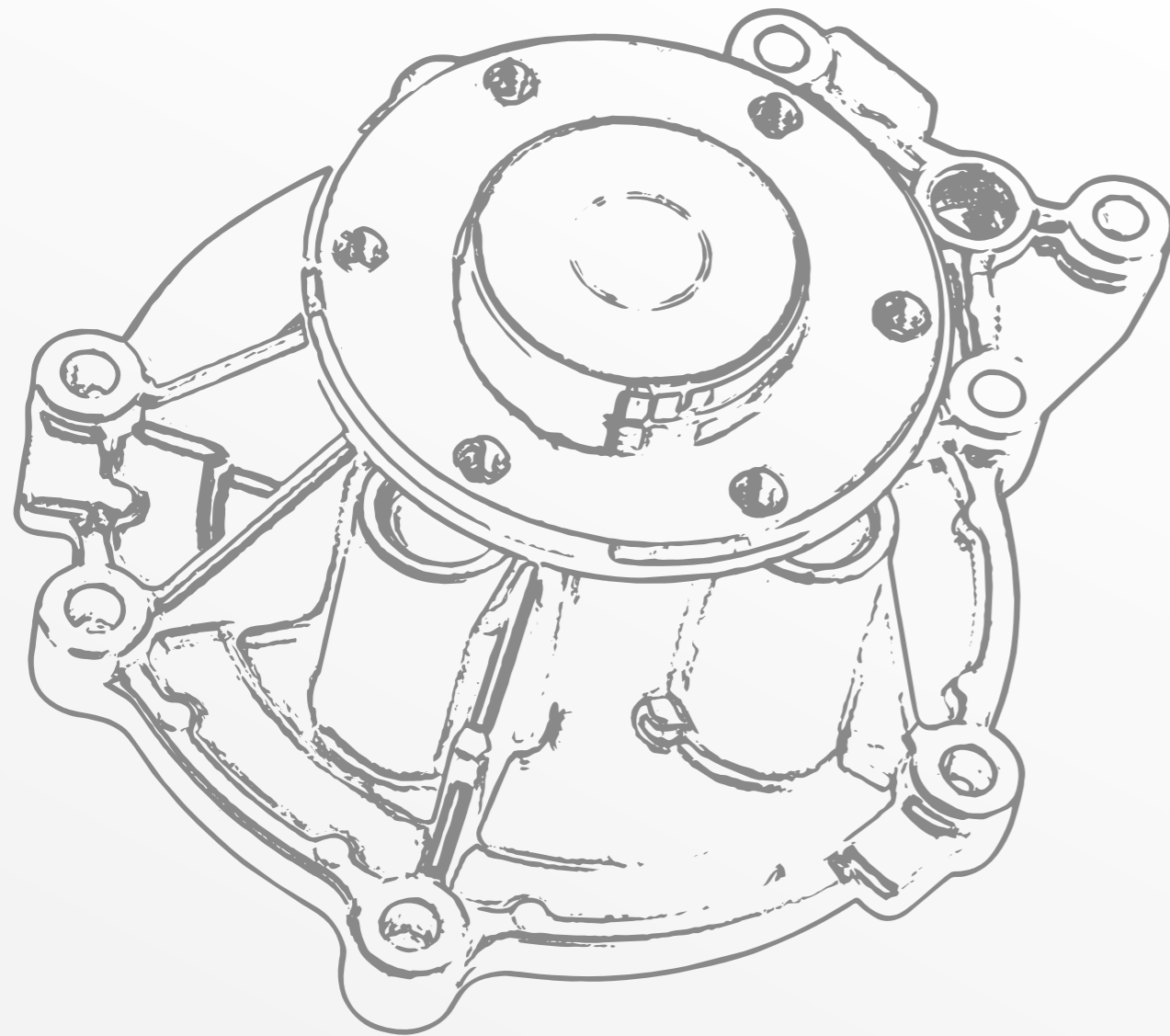

**M.A.N.**





	ENGINE	OE NUMBER		ENGINE	OE NUMBER
	D 2865 D 2866 D 2876	51.06500-6479 51.06500-9479		D 2865 D 2866 D 2876	51.06500-6426 51.06500-9426
	D 2540 MTF/MTH D 2566 MKUL D 2840 LF/LXF D 2865 LF/LFR/ LXF/LXFR/LU D 2866 F/FR/TUH/ TUM/UH/UM	51.06500-6408 51.06500-9408		D 2530 D 2538 D 2565 D 2566 D 2866 F/FR/ TUH/TUM/ UH/UM	51.06500-6282 51.06500-6387 51.06500-9282 51.06500-9387
	D 2530 D 2538 D 2565 D 2566	51.06500-6228 51.06500-6229 51.06500-6225 51.06500-6224 51.06500-6223 51.06500-6222 51.06500-6221 51.06500-6219 51.06500-6218		D 0824 LFL01/02/ 04 D 0824 LOH01~05 D 0826 LFL03/06 D 0824 LF01/02 D 0826 LOH15/ 17~19 D 0826 LF1/17/18 D 0826 LFG15/16 D 0826 LF/LF217 LF01/02	51.06500-6537 51.06500-9537
	D 0836 LFL 01~06 D 0836 LF 01/03~05 D 0834 LFL 01	51.06500-6606 51.06500-6612 51.06500-6575 51.06500-9606 51.06500-9612 51.06500-9575		D 0826 LOH 01~08 D 0826 LF/LF 217 LF01/02/04~08 D 2865 LF21/22/23	51.06500-6495 51.06500-6463 51.06500-9495 51.06500-3178
	D 0824 LF01/02 D 0826 LOH 01~08 D 0826 LFG01/02/06 D 0826 LF/LF 217 LF01/02/04~08	51.06500.6476 51.06500-9476 51.06500-6462 51.06500-9462		D 2865 LF D 2866 LF D 2876 LF	51.06500-6546 51.06500-9546

M.A.N.

## WATER PUMP / WASSERPUMPEN

	ENGINE	OE NUMBER		ENGINE	OE NUMBER
	D 0824 LFL01/02/04 D 0824 LOH01~05 D 0826 LFL03/06 D 0824 LF01/02 D 0826 LOH15/17~19 D 0826 LF1/17/18 D 0826 LFG15/16 D 0826 LF/LF217	51.06599-6067		D 0836 LFL 01~06 D 0836 LF 01/03~05 D 0834 LFL 01	51.06599-6081
	D 0824 LF01/02 D 0826 LOH 01~08 D 0826 LFG01/02/06 D 0826 LF/LF 217 LF01/02/04~08	51.06500-6052		F 2000 series	51.06500-6547 51.06500.9547
	F 2000 series	51.06500.6548 51.06500.9548		F 90 series F 2000 series	51.06500.6492
	18363 ECT D2876LF05 D2876LF13 D2876LF12	51.06500.9066 51.06500.7045 51.06500.7047 51.06500.7048 51.06500.7065 51.06500.7066 51.06500.9048 51.06500.9052 51.06500.7052		D 2865 D 2866 D 2876	51.06599.6033 51.06599.6010 51.06599.6011 51.06599.6012 51.06599.6035
				MAN TGA D20 D 2066 B 2076	51.06500.7049 51.06500.6637 51.06500.9049





## WATER PUMP / WASSERPUMPEN

	ENGINE	OE NUMBER		ENGINE	OE NUMBER
	D 2566 D 2840 D 2865 D 2866 D 2876	51.06599.6013		D 0826	51.06500.6480 51.06500.9480
	D 0826	51.06500.6543 51.06500.9543 51.06500.6569 51.06500.9569		D 0824 D 0826	51.06500 6515 51.06500 6532 51.06500 9515 51.06500.9532
	D 2066 D 2676	51.06500-6676 51.06500-6646 51.06500-9646 51.06500-9050		D 0836 D 0834	51.06500 6679 51.06500 7078 51.06500 7064 51.06500 9078 51.06500-9064 51.06500-6699 51.06500-9679
	D 0836 D 0834	51.06500 6680 51.06500 7070 51.06500 7079 51.06500 9079 51.06500.6651 51.06500.9651 51.06500.9680			51.06599 6055
		REPAIR KIT FOR VS-MN117			51.06599-6086 R

## WATER PUMP / WASSERPUMPEN

	ENGINE	OE NUMBER		ENGINE	OE NUMBER
		51.06500 6091		D 2066 D 2076	51.06500-6642 51.06500-9642 51.06500-6675 51.06500-9675 51.06500-9694
	D 0836 D 0834	51.06500-6587 51.06500-6594 51.06500-9587		ENVIRO 400 EURO 5	51.06500-6673 51.06500-9673 51.06500-9692 51.06500-6692
	EURO 5	51.06500-6674 51.06500-9698 51.06500-9674 51.06500-9668 51.06500-6698 51.06500-6668		EURO 4 FOR MN133 FOR MN125	51.06330-5040 51.06500-5034
	D 2066	51.06330-5048 51.06330-5019		D 2842 D 2840	51065006472 51065006458 51065006281 51065009472
	D 2066 D 2676	51.06330-5047 51.06330-3035		TGA/TGM/ TGS/TGX L 2000 G 90 Cityliner	51.06500.7130 51.06500-7102 51.06500-7106

## WATER PUMP / WASSERPUMPEN

	ENGINE	OE NUMBER		ENGINE	OE NUMBER
	TGS/TGX	51.06500.7138		TGS/TGX	51.06500.7128
	D 2066 D 2676	51.06500.7131		Fendt Vario 916/918NA/ 920/920NA/ 924/924NA/ 926/926NA/ 930/930NA	51.06500.6617

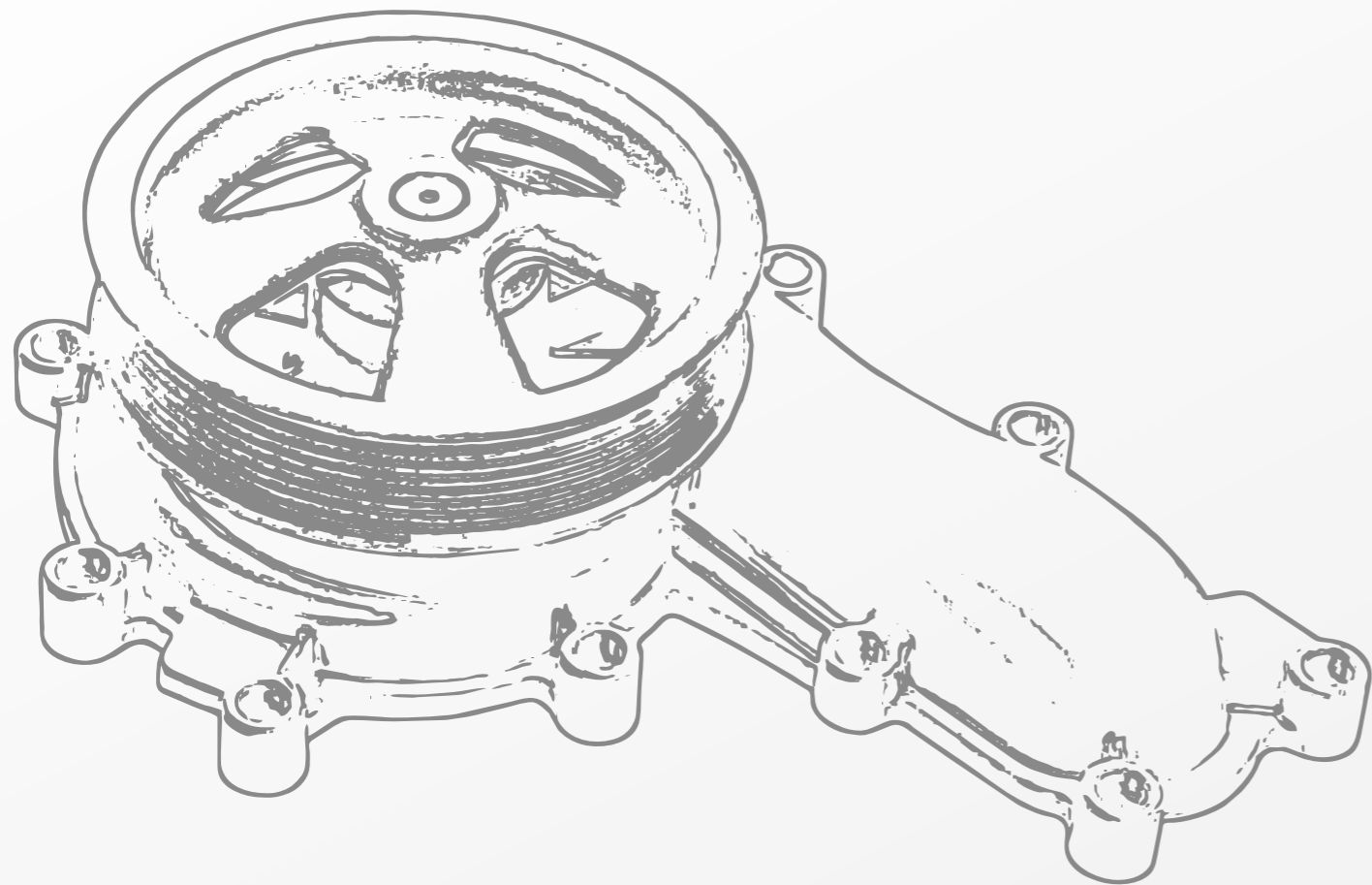











**SCANIA**

**WATER PUMP / WASSERPUMPEN**











	ENGINE	OE NUMBER		ENGINE	OE NUMBER
	DS 11 DSC 11 DN 11 DS 11 DSC 11 DTC 11	1 314 406 1 575 100 1 571 059 575 100 571 059 292 761 290 865 524 866		DS 11 DSC 11 DN 11 DS 11 DSC 11 DTC 11	REPAIR KIT FOR VS-SC101
	D 11 DS 11	259 065 571 055 258 263 235 310 228 826		DSC 11 DSC 12 D 9/11/12 DC 9/19	1 508 533 1 353 072 570 951 570 955 1 372 365 1 896 752 570 962
	DSC 14 D 14	1 508 534 1 365 841 1 365 481 570 952 570 956		DS 11 DSC 11 DN 11 DTC 11	550 167
	DS 11 DSC 11 DN 11 DTC 11	550 044		R/T143	320 592 292 762
		FAN MOUNT		DC 9	1 510 490 1 486 098 1 380 897 570 957 570 953 571 157 570 961

SCANIA

## WATER PUMP / WASSERPUMPEN

	ENGINE	OE NUMBER		ENGINE	OE NUMBER
	DN9 DS9 DSC9L DS9B DSC9B	1 338 490 1 377 571 571 067 571 066 397 957 369 902 347 963 571 065		PRT 113 K 113	1 354 103 1 314 336 571 150 1 354 403
		550 167			500142+550044
	DSC 14 03 DSC 14 06 DSC 14L	550206+551476		DSC 11 DSC 12	551355
	DSC 14	551369		D16/A/M DSC16	1 549 482 1 793 989 570 958 570 954 570 881
	DC 9/19/20/21 D 9/11/12	1 789 522 1 546 188 570 964 570 959 1 787 123		FOR SC119	1528348 1787121

## WATER PUMP / WASSERPUMPEN

	ENGINE	OE NUMBER		ENGINE	OE NUMBER
	FOR SC104	1 450 153 1 376 495		DSC 13	1 778 923 570 193
	DSC 14	1 375 838 1 375 837 382 183 571 153		DSC 14	1 375 839 1 375 840 1 362 261 571 154 571 155
	DC 9 DC 11 DC 12 DSC 14	1787120 970965		D 13 DC 13 D 9	16625769
	FOR SC118	1793990 1423397		D 13 DC 13 D 9	2224112 2034084 2006397 1884327 1789555 576662
	DC 16 DC 16 XPI	2363452		DC 16 DC 16 XPI	2363639

# WATER PUMP / WASSERPUMPEN

ENGINE    OE NUMBER

L/P/G/R/S  
2714201  
2730981  
573133

ENGINE    OE NUMBER



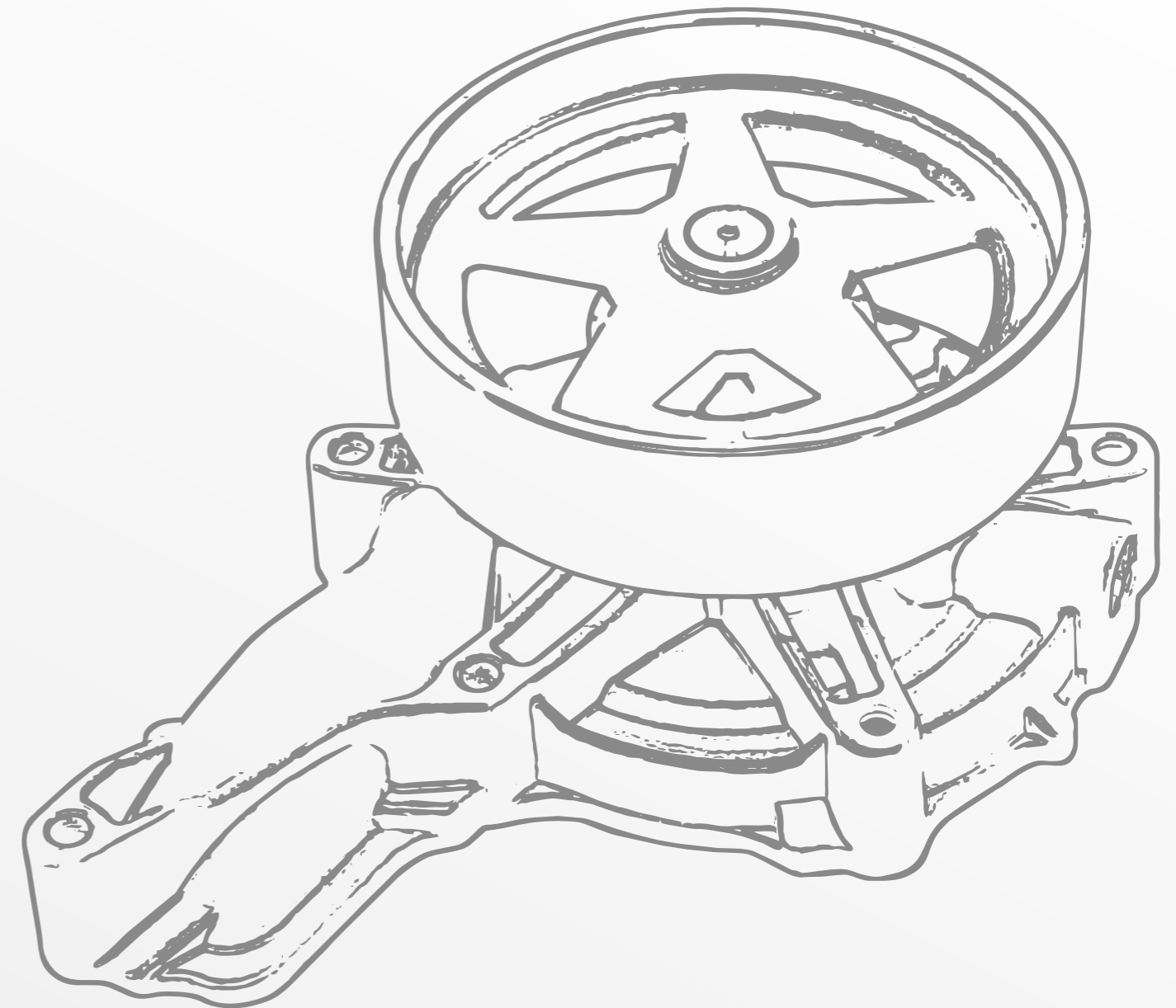





2422589



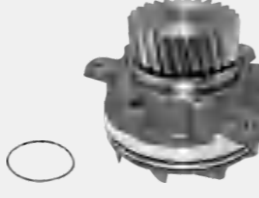



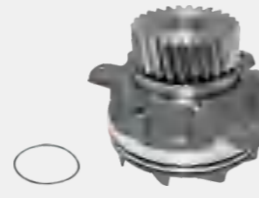

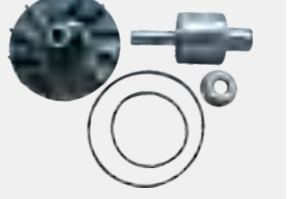

**VOLVO**

SCANIA







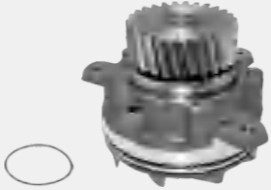

## WATER PUMP / WASSERPUMPEN

	ENGINE	OE NUMBER		ENGINE	OE NUMBER
	TD101/102/103 TD121/122/123	20 431 484 1 545 261 8 149 937 1 699 790 1 698 620 1 675 945		TD 61 TD 63 D 7 D 6 TD 71 TD 73	8 192 050 3 183 908 477 770
	TD 61 TD 63 D 7 D 6 TD 71 TD 73	8510 7763 276835 276803 276054 276942		D 12C	8 170 305 8 113 274
	N 10TD 101G N 10TD 100G	276800		D 12A D 12B	8 149 882 1 676 713 8 113 155 8 112 889
	D 12A	8 149 941 8 148 460 8 113 117 1 547 155 8 112 275 1 001 698		D 12A	20 431 135 20 713 787 20 734 268 8 170 833 20 431 151 20 431 137 8 113 274 85 000 452 8 113 275
	TD 101 TD 121			TD 102 TD 122	270791 275615 276802

## WATER PUMP / WASSERPUMPEN

	ENGINE	OE NUMBER		ENGINE	OE NUMBER
	TD 103 TD 123	276814			REPAIR KIT FOR VS-VL109
	D 9A D 9B	20 857 085 20 411 880 85 000 214 21 076 088		D 9A	20 538 845 20 744 939 21 468 471 21 228 793 85 000 486 20 761 306
	D 9	3 161 436 85 000 062 3 803 930 3 803 844 3 801 484		TD520 GE TD720 GE	20 834 409 20 997 647 20 997 650 21 417 491 3 801 244 3 801 164 85 003 894
		2053 845 2074 4939 2146 8471 2122 8793 8500 0486 2076 1306			9858 2037
		9858 2038			REPAIR KIT FOR VS-VL104

# WATER PUMP / WASSERPUMPEN

ENGINE	OE NUMBER	ENGINE	OE NUMBER
			
	TD 100 1 699 788 TD 101 1 545 248 TD 102 1 698 618 PULLEY 131mm 467 907 467 686 8 112 521		FOR VL116 22 195 464 FOR VL137 21 284 318 20 505 543 85 003 269
			
	FOR VL117 20 431 584		EURO 5 21 969 187 EURO 6 21 969 188 D11K 21 648 716 D11C
			
	EURO 5 216 487 08 D13C 209 200 85 EURO 6 219 691 83 D13K		N 10 1699788 PULLEY 120mm 1699789
			
	FE/FL 2013- 23552770 B 5 TL/LH/LHC B 8 L/R		D13C 21648711 D13K 20920065 D13T 85000957 FH13 85013057 FM13
			

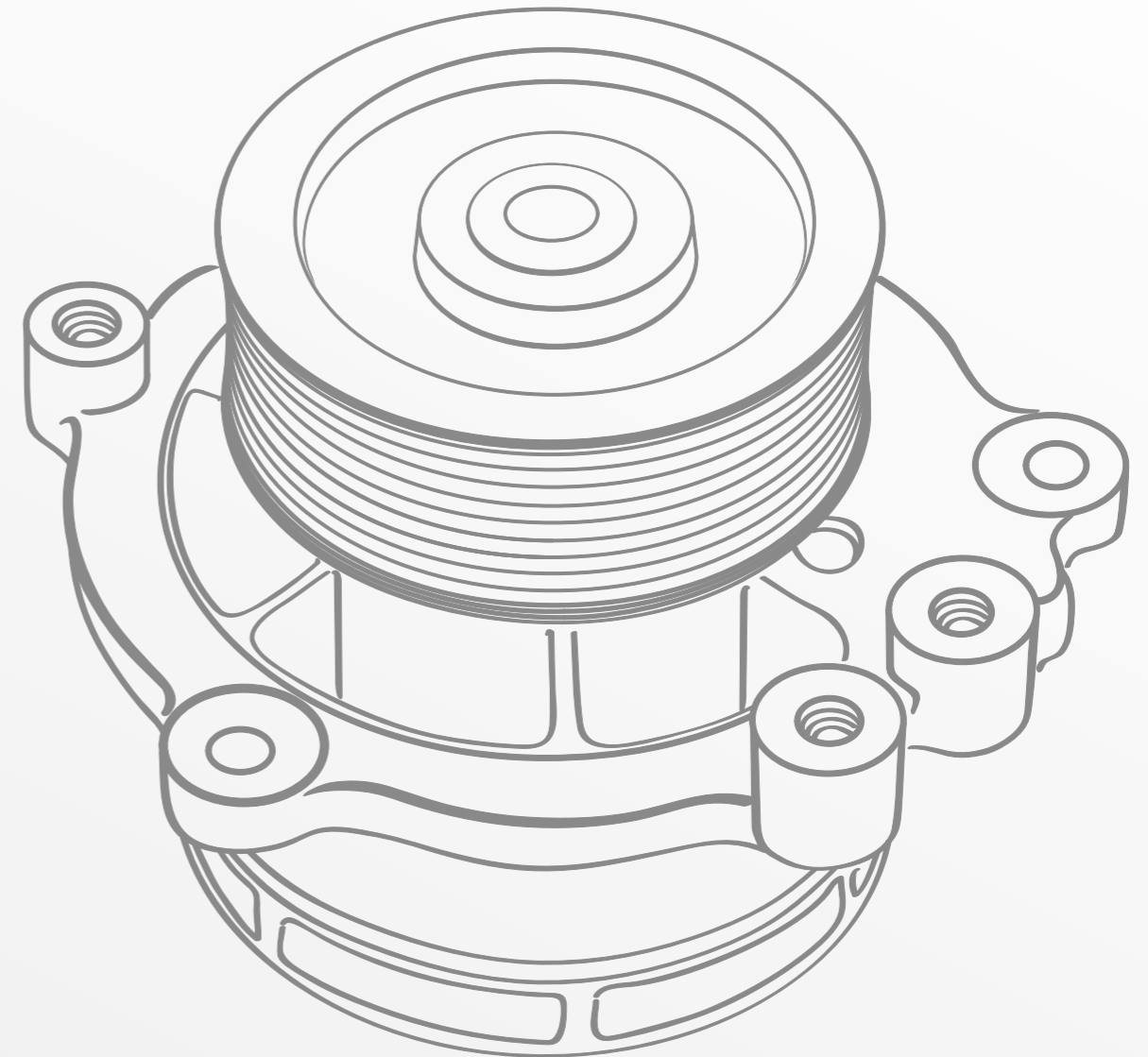





# IVECO









## WATER PUMP / WASSERPUMPEN

	ENGINE	OE NUMBER		ENGINE	OE NUMBER
	8040.20 8040.05 8040.04 8040.24 8060.12 8040.02 8060.02	93191101 4679242 463 9182 465 5010 465 5054		8040.05 8040.25 8040.05 8060.05	98 497 117 98 465 322 4 813 370 98 415 712 4 813 371 4 784 454 504 290 853
	8210.42	500 350 785 42 530 033 93 190 287 93 190 285 98 447 661 99 445 447 98 479 675		8210.42	
	8460.SPR	500350798 93190284 93190288		8210.42	42 530 032 93 190 286 61 315 472 503 475 055
	6CYL.7685	42 535 615 52 532 082		Daily 2006 M.Y	504 087 367
	EUROTRAKKER E.TECHCURSOR STRAILS	500 356 553		TECTOR 75E13	504 062 854 503 662 660

## WATER PUMP / WASSERPUMPEN

	ENGINE	OE NUMBER		ENGINE	OE NUMBER
	EUROTRAKKER EUROTECH EUROMOV EREUROTRAKK ER STRALIS	99 483 937 99 460 305 5 001 859 590 504 201 935 5 801 931 331 926 371		CURSOR 8	504 029 280 5 801 702 443
	A35.12-A49.12- A59.12 A30.8-A35.8- A40.8 A35.10-A45.10- A49.10	500 361 919 99 438 900 500 361 203 98 438 356 99 448 068 500 300 476		315.8.18POK ER III 6CYL.5861CM3	98 415 831
	190PC26-190.26h 190PC30- 190.30H 260PC26- 260.26H 33.30H 330PC26- 330.26H	580 1931 141		60.11-65.12-79.12 79.14-95.14-109.14 4SERIE 95.14 109.14 110.14P(4*4) 115.14-135.14- 1 E 2 SERIE 115.17-135.17 1 E 2 SERIE 135.17(VENE ZUELA) 145.17-150.17(CI LE-ARGENTINA) 175.17	98 497 115 4 835 043
	CF85 XF95/105	1 778 280 1 664 762 1 828 162 0 931 147		Daily II Daily III	500 362 859 99 479 817
	A35.12-A49.12 -A59.12 A30.8-A35.8- A40.8A35.10- A45.10-A49.10	500 362 834 500 1851 798 500 361 455		A35.12-A49.12 -A59.12 A30.8-A35.8- A40.8A35.10- A45.10-A49.10	761 312 4 538 058

## WATER PUMP / WASSERPUMPEN

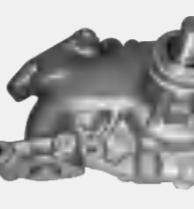
	ENGINE	OE NUMBER		ENGINE	OE NUMBER
	Ducato 243/244/245/247 Daily III Daily IV Daily V Daily VI	504 033 770			
	Daily III Daily IV Daily V Daily VI	504 113 544		500 300 470 4 812 406	
				Ducato 250/251/252/254 Daily V	504 248 581 504 102 572
		4 752 137		Daily III Daily IV Daily V Daily VI	504360207
		93190288			4710552





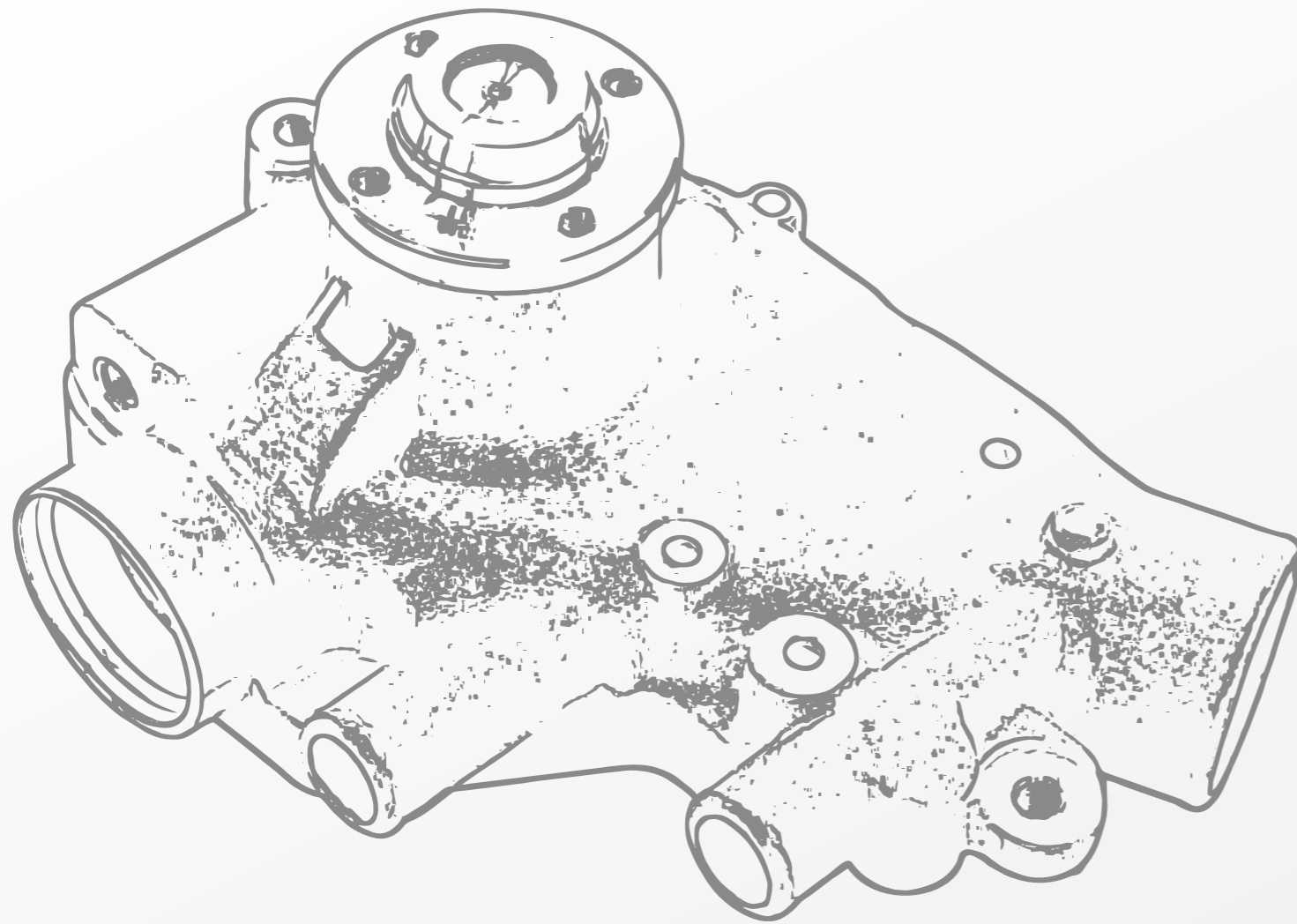

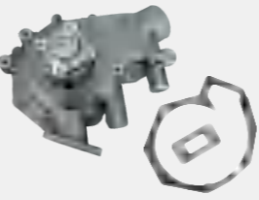

## WATER PUMP / WASSERPUMPEN

	ENGINE	OE NUMBER		ENGINE	OE NUMBER
		4764156		AD/AT/AS Stralis AD/AT/AS X-Way S-Way PULLEY 120mm	5801938457
	AD/AT/AS Stralis AD/AT Trakker Astra HD 9 T-Way PULLEY 130mm	5801938449			

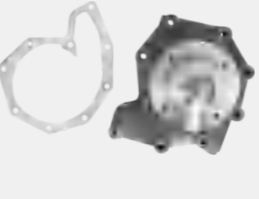
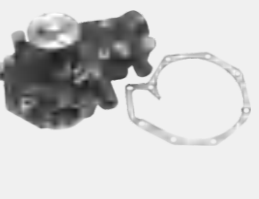

**DAF**

**WATER PUMP / WASSERPUMPEN**

	ENGINE	OE NUMBER		ENGINE	OE NUMBER
	80 85 95.330 95.460	0 682 968 0 682 258 0 681 653 372 896		2100 2300 2500	0 682 263 0 680 217
	3300	0 682 260 0 517 097 0 506 109		2800 3300 3600	0 682 262 0 680 156
	F65 F1100 F1300 F1700 F2300 65CF	0 682 958 0 682 271 0 681 460		XF 85 XF 95 XF 355 XF 250M XF 280M XF 315M	0 683 225 0 683 386 9 963 225 1 609 871
	2100 2300 2500	0 682 264 0 624 147		F 2100 F 2300 F 2500	REPAIR KIT FOR VS-DF102 VS-DF107
	600 800 1000 45ALL MODELS 55ALL MODELS	CBU2148 CBU2396 CBU1131 CBU1909 CBU2714 1399689		DT615	680520

DAF

## WATER PUMP / WASSERPUMPEN

	ENGINE	OE NUMBER		ENGINE	OE NUMBER
	865 RS	0 682 747		XE250C XE280C XE315C XE355C XE390C	0 683 579 1 609 853 1 399 150 1 399 336
	1260 VS	1 778 280 1 664 762 1 828 162 0 931 147 1 653 974 1 742 258 1 742 259 1 747 962 1 747 963		PF183M PF212M PF235M	683 338
	75CF 85XF	0 683 580 1 441 060 1 609 854		ME EPA04	1942598 1859821
	EURO 6XF/CF PLUG RIGHT IMPELLER 116MM	1922223 1934326 1979914 1979951 1993418 1995152 2104574R		EURO 6XF/CF PLUG LEFT IMPELLER 113MM	2104577
	EURO 6XF/CF PLUG LEFT IMPELLER 106MM	2104578		EURO 6CF,XF IMPELLER 113mm	1912939 1912939R 1917690 1945428 1953276 1956779 2042162R

## WATER PUMP / WASSERPUMPEN

	ENGINE	OE NUMBER		ENGINE	OE NUMBER
	EURO 6CF,XF IMPELLER 106mm	1912940 2042161 2042161R		EURO 6CF,XF IMPELLER 116mm	2104575
	EURO 6CF,XF IMPELLER 106mm	2104580 1956781 1949546 1953398		EURO 6CF,XF IMPELLER 116mm	2104576 2003494
	EURO 6 XF	2137204		EURO 6 CF/XF	2104579
	CF 75IV	1734841		DAF	2184200
	EURO 6 CF/XF	2137201 2184198R 2267059R			

# WATER PUMP / WASSERPUMPEN

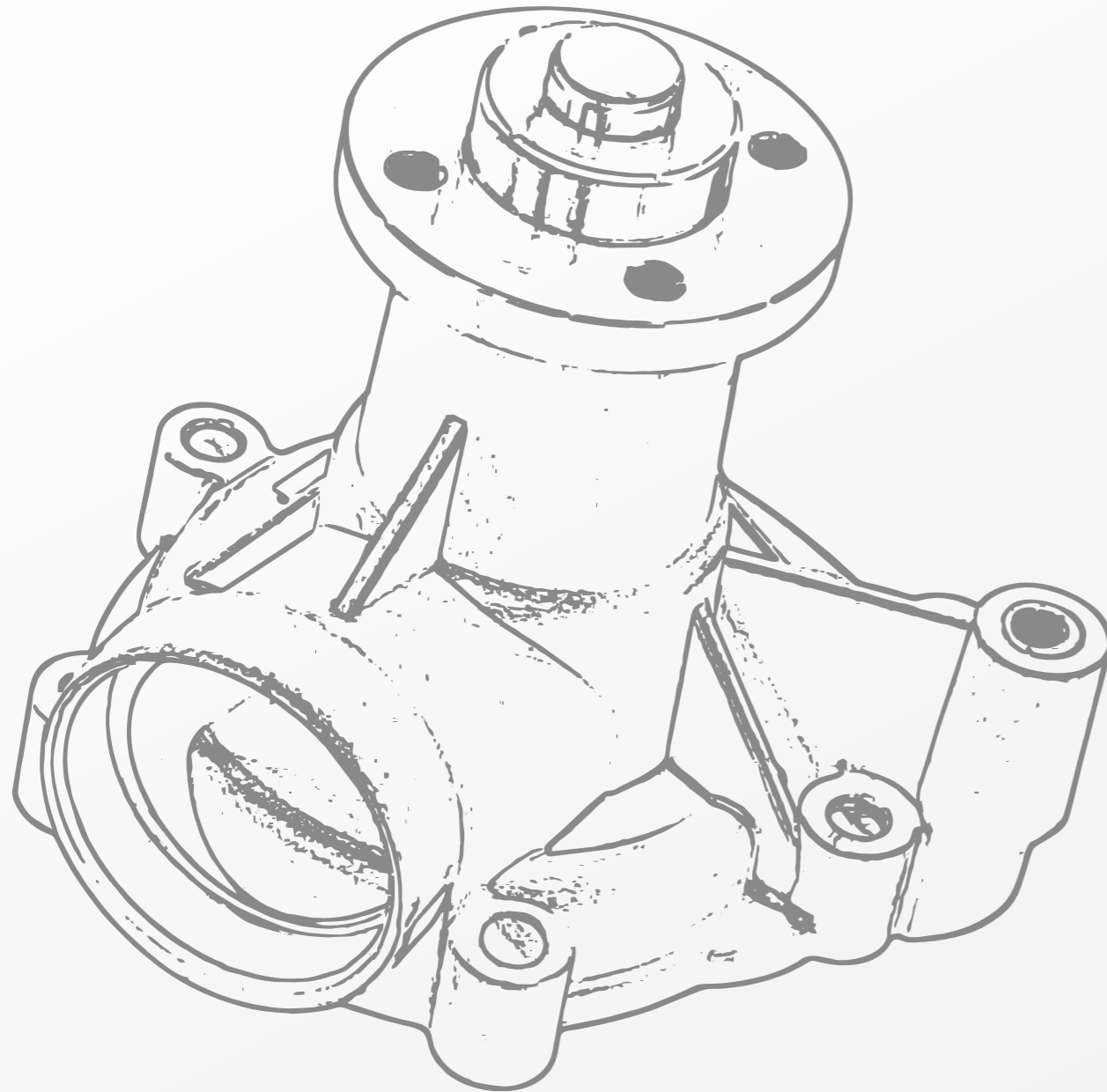

**DEUTZ**





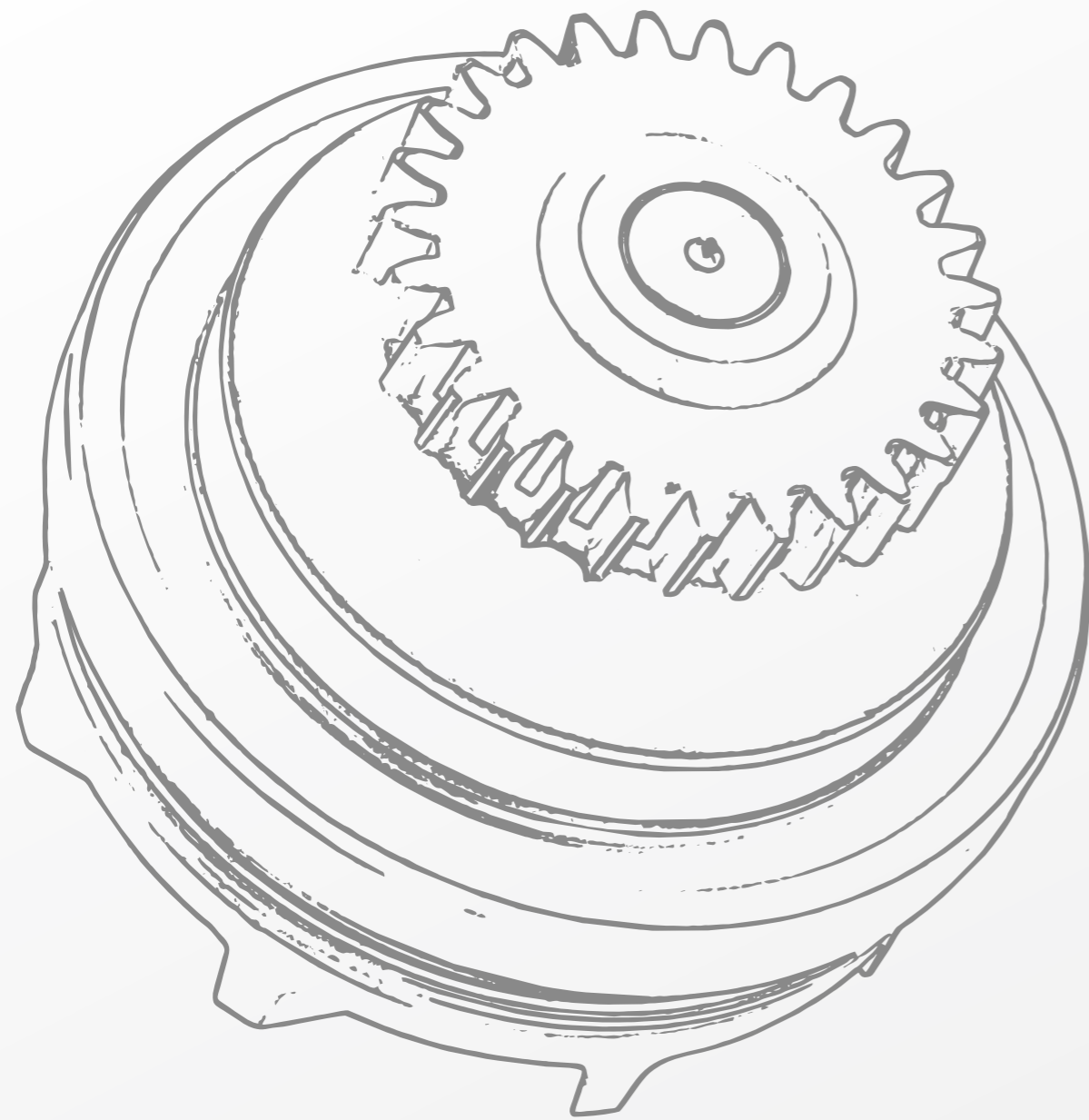



	ENGINE	OE NUMBER		ENGINE	OE NUMBER
	BF6M1013 TAD420/620 VE	04 206 747		BF6M1015 D7/5 D D8 H D9 B	04 204 095
	BF6M1013 D4/5/6/7	0 450 930		D5 D TD520/720	042 569 59R 21 727 936 21 461 864 20 726 077 20 405 685
	TD 63	1 131 121 11 127 755			04 283 172
					1307050-B321/A

DEUTZ



**RENAULT**

**WATER PUMP / WASSERPUMPEN**

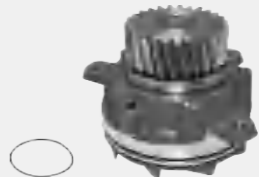
	ENGINE	OE NUMBER		ENGINE	OE NUMBER
	C210-CLR220 MIDR 06.20.045 C230-C260MI DR 06.20.045 E/3 C280-C290 C300-CCH300 C340T1 G210-G220 R312-G320 R310-R330	5 000 670 157 5 001 837 298 5 000 681 283		C210-19MIDS 06.20.30 G210.17-G210.1 9MIDS 06.20.45 G230.17-G230.1 9MIDR 06.20.45 CLR 220 G260.11-G260.13 G260.16-G260.19 G260.17T G260.17TD	5 000 663 121 5 001 837 295
	PREMIUM FA B22CC TRACTEUR	5 001 858 484 5 001 857 427 5 001 585 005 5 010 550 552 5 010 477 162 5 010 477 321 5 010 477 734 5 010 550 550		PR 10S MIDS 06.20.30 PR 12 S MIP 06.20.30 PR 14 S/640 MI PS 06.20.30 PR 14 S/641 PG 60 - G45 - G 105 PR 100 MI PR 180	5 000 663 009
	MAGNUM MD IR06.35.40 AE380-AE420 MDR 06.35.A R385 MAJOR- 385 TI R420 MAJOR- 420TI	5 010 248 921 5 101 837 322		R310-R330 MD 06.35.40 R340-R365 MDS 06.35.40 CBH280-CBH340 MIDS 06.35.40 AE380-AE420 M DR 06.35.40 R385MAJOR-385 TI DR 06.35.40 R420MAJOR-420T IMIDR 06.35.40A	5 010 323 187 5 001 837 314
	D2566 D2530 D2538	5 000 286 186		GR251-TR251D 2566 MTSF PS30 - Hi38	5 000 281 838 5 000 280 678
	DXI 11	7 420 744 940 7 485 000 763 7 420 538 845 7 420 744 939		MAGNUM DX112 DX113	5 001 866 278 7 420 734 268

RENAULT





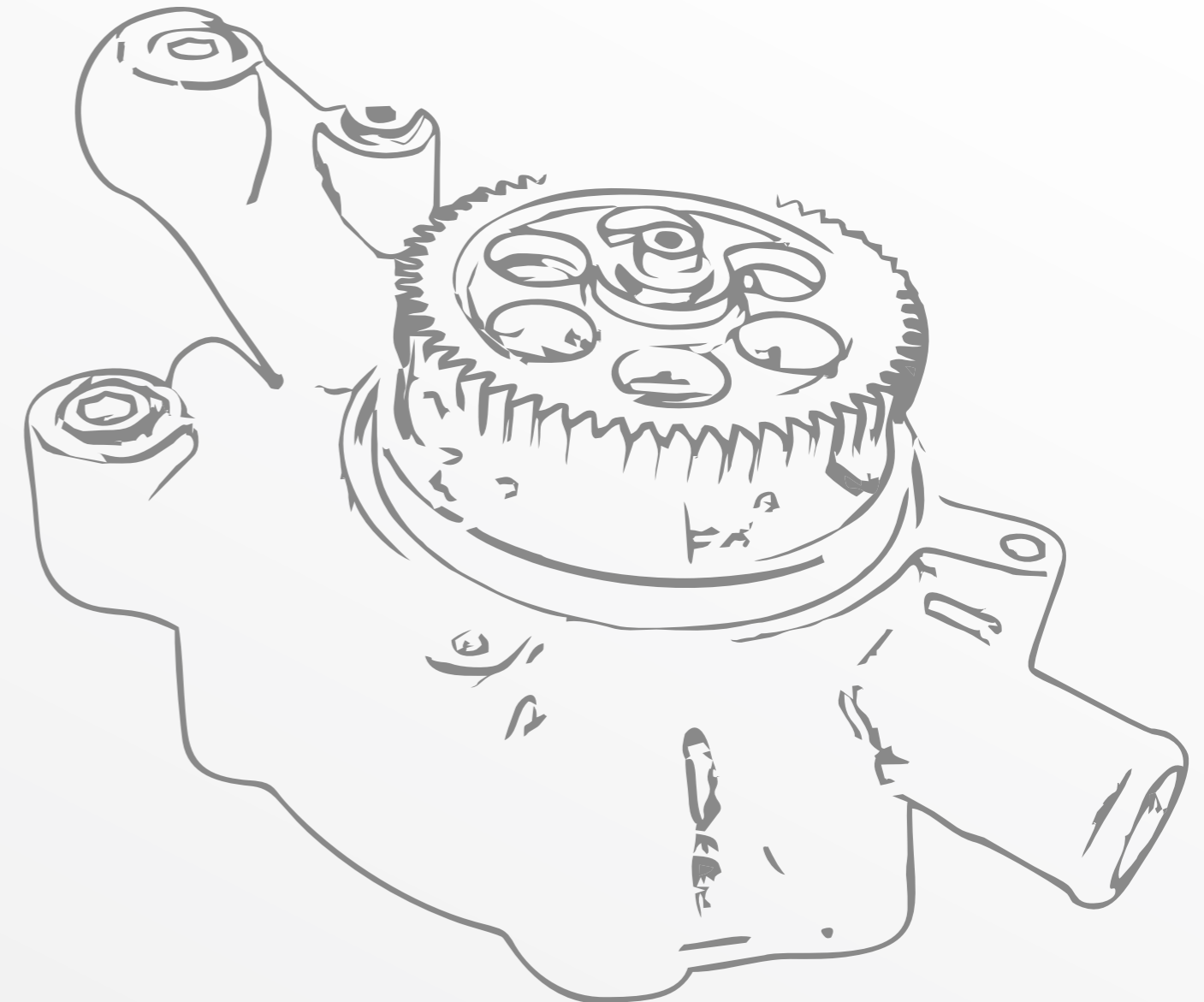

# WATER PUMP / WASSERPUMPEN

	ENGINE	OE NUMBER		ENGINE	OE NUMBER
	M140-M160MIDR 06.20.45B M200-M230MIDS 06.20.45B S140-S160 PS150-PS160 S 170	5 010 258 978 5 001 837 292 5 010 450 735		M140-M160MIDR 06.20.45B M200-M230MIDS 06.20.45B S140-S160 PS150-PS160 S 170	5 600 409 620 5 010 258 977 2 001 837 288
	MIDR 06.20.45 MIDR 06.20.30	5 010 330 029 5 001 837 265			5 001 849 884 5 001 837 268
		5 000 297 602 5 001 837 265		TD 520 TD 720	7 420 834 409 7 420 997 647 7 420 997 650
	MIDR 062 465	5 001 837 331 5 001 870 446 5 001 845 328 5 200 538 288 5 010 284 179 2 010 438 102 316 GC3 195			5 001 863 728 5 001 863 754 5 001 875 237 7 485 003 149
		5 001 837 322 5 010 248 921 5 010 553 652		M/S/ME/SE/CE	5 010 450 892 5 001 865 041 7 422 485 206



# DETROIT





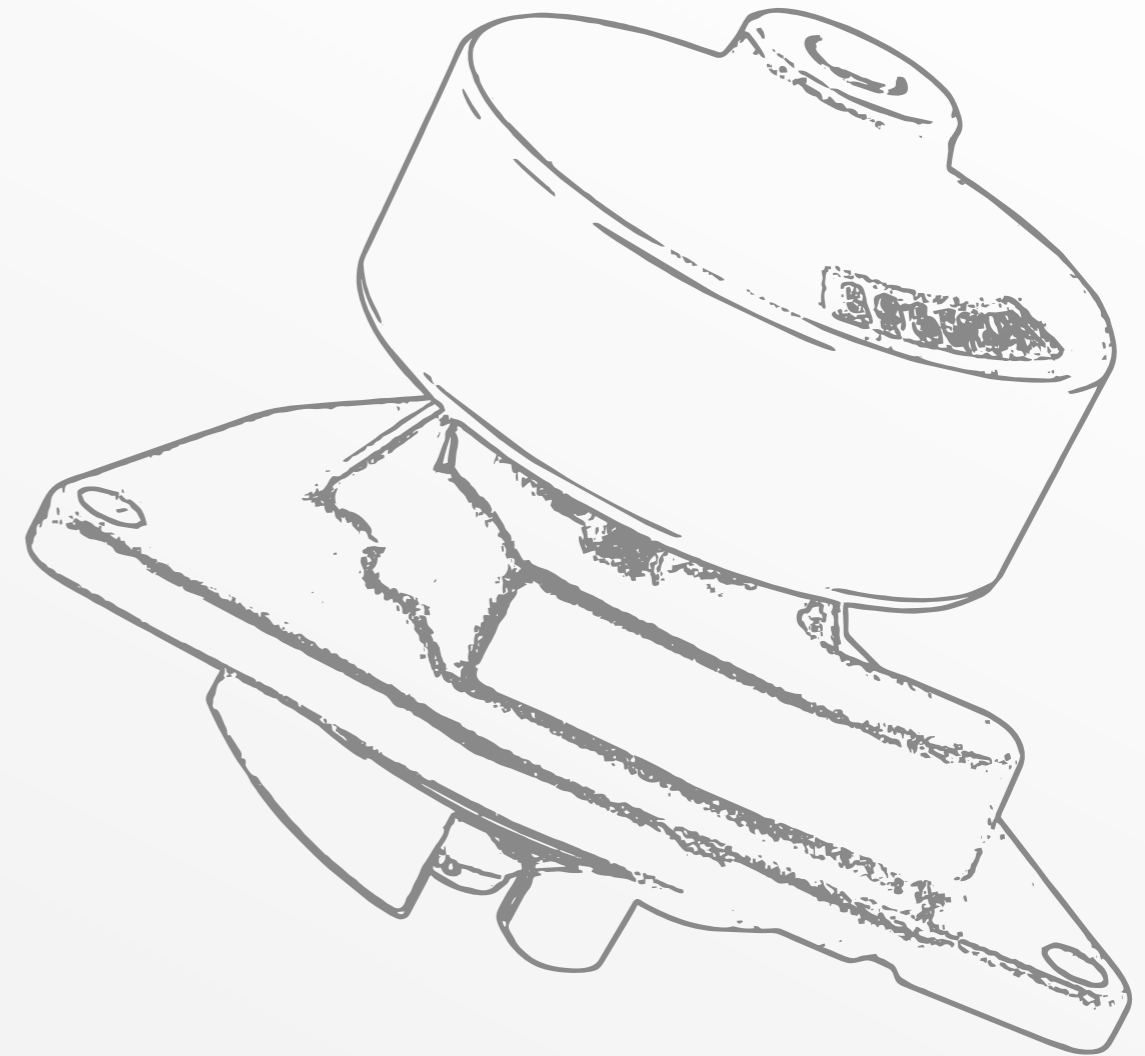





## WATER PUMP / WASSERPUMPEN

	ENGINE	OE NUMBER		ENGINE	OE NUMBER
	60 series	23 522 707 235 326 039 23 517 027 23 505 895 23 518 215		60 series 12.7L GEAR 147MM 57 TEETH	AW2 130 23 532 543 23 531 258 23 535 018
	60 series 14.01	25 532 542 AW2 129 23 535 017 23 531 257 23 535 017		60 series	23522721
	DD13/15	4722000001 4722000101 4722000401		8.2 LITER	8928672
	GEAR 125MM 49 TEETH	23535502			

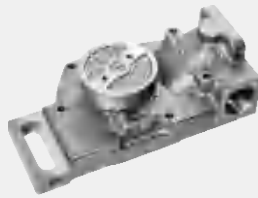

# CUMMINS











## WATER PUMP / WASSERPUMPEN

	ENGINE	OE NUMBER		ENGINE	OE NUMBER
	B Series Diesel, (3.9L) 4 Cyl, 237 4 Cyl. & (5.9L) 359 6 Cyl.	3 802 358 3 903 749 3 802 970 3 913 432 3 802 004 3 286 277 3 286 275 3 285 410		C Series(8.3L) Short Nose, FD 1460 504 (8.3L) 6 Cyl.	3802081 3804883RX F3HZ8501B 3806180
	Cummins B Series	3926203		6C 230 Series	3966841
	6CT8.3	3929612		BIG CAM IV 855 (MULTL GRV PULLEY)	3801708 3045943RX
	N41	3803605 3803361		BIG CAM 855 NTC 290,359,400 MULTI GRV PU LLEY	3801788 3022474
	M11 & L10 E SERIES 1991 AND LAT ER 3 HOLE MOUNT	3803403		ISX PULLEY 118.5MM 10 SLOTS	4089908











## WATER PUMP / WASSERPUMPEN

	ENGINE	OE NUMBER		ENGINE	OE NUMBER
		4892175			2854835
		2853114			3801840 3825540 3803402
	ISX PULLEY 138.5MM 12 SLOTS	4089910			3800975
	ISC & ISL 8.3 LITERS 8.9L	3800974 3926912 3923568 3285323			3800976 3285324 3925540 3926914
		3804927 3940052 4089647		ISC 8.3L 505	AW6661 WP-2340 3940052 4089952





## WATER PUMP / WASSERPUMPEN

	ENGINE	OE NUMBER		ENGINE	OE NUMBER
	ISX PULLEY 128MM 12 SLOTS	4089911			3 800 984
	ISX/ISZ	3 694 449			
		3 800 745		N-14	3 804 826
				ISX/ISZ	368 713 0NX
	WITH BACK COVER			ISX/ISZ	3 684 450 3 683 651

## WATER PUMP / WASSERPUMPEN

	ENGINE	OE NUMBER		ENGINE	OE NUMBER
		2 882 038			3 000 886 AR45090 381 784
	4B	3 937 404		6CT	3 930 338
	ISC	3 966 840			
	ISL	4 941 464		K19	3 047 549
	4B	4 939 586		M11	4 003 950





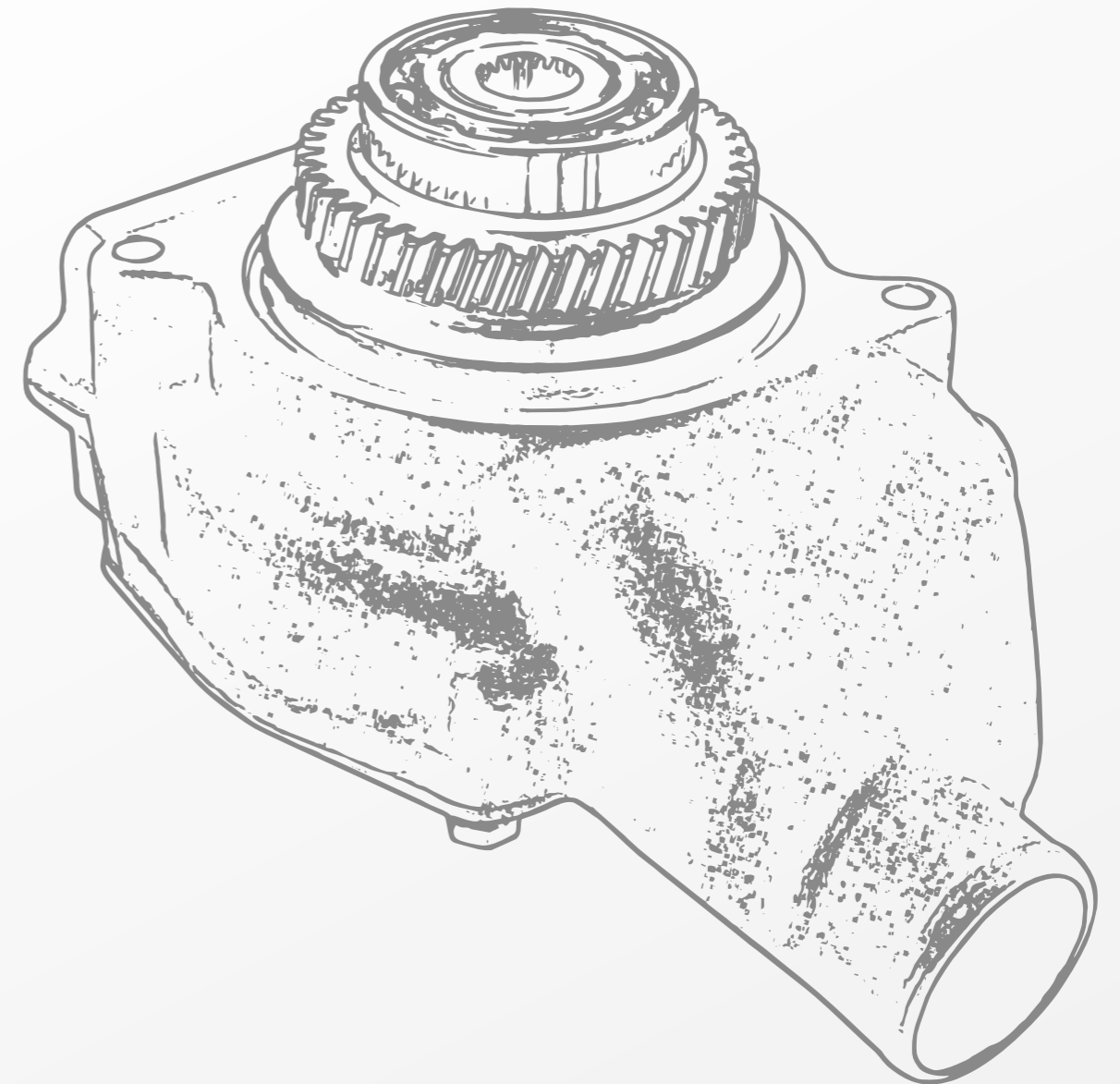



## WATER PUMP / WASSERPUMPEN

	ENGINE	OE NUMBER		ENGINE	OE NUMBER
	NT 855	3042 378		QSX15	
	ISX15	3 687 527		K38	3 634 640



# CATERPILLAR



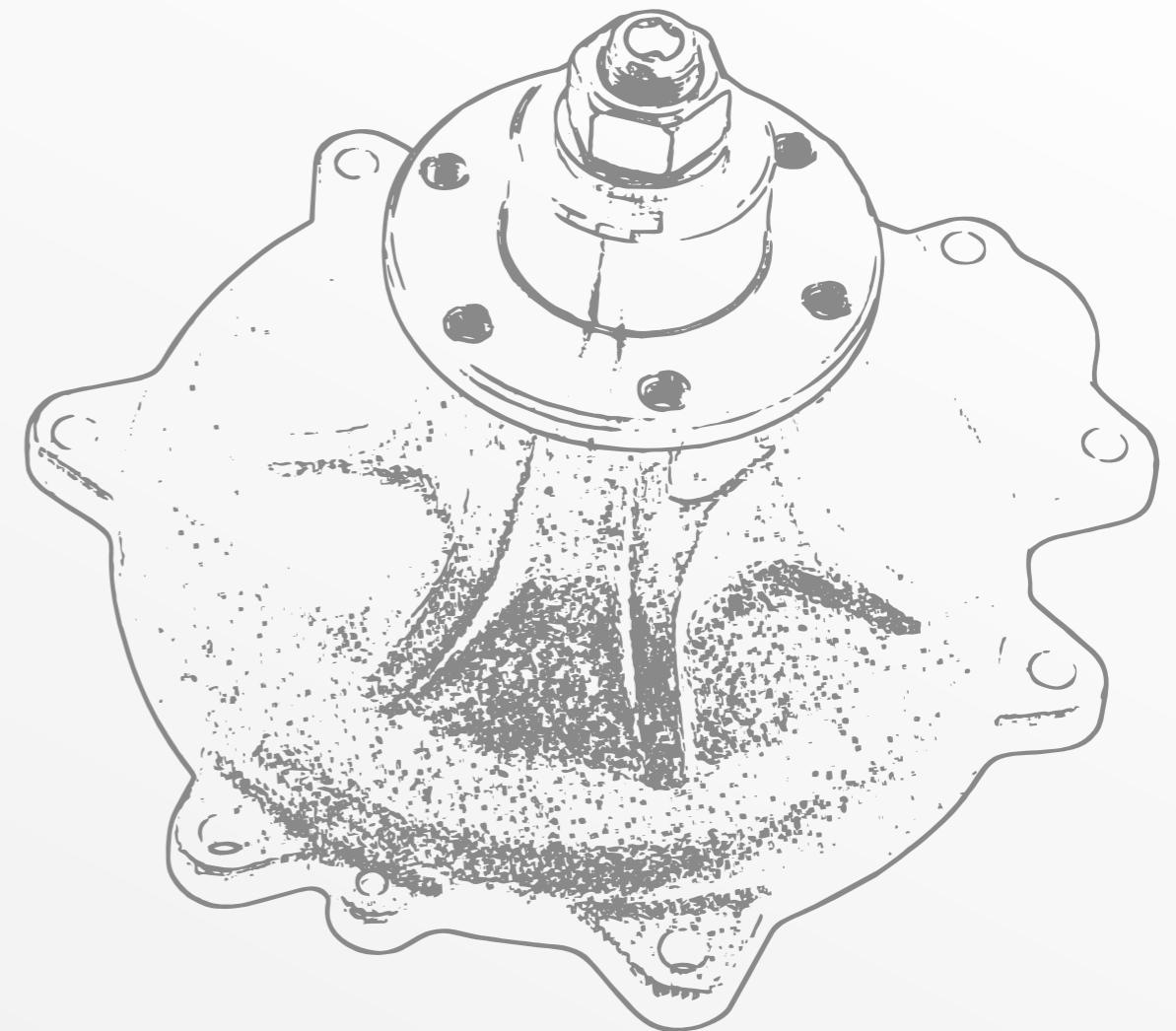

## WATER PUMP / WASSERPUMPEN

	ENGINE	OE NUMBER		ENGINE	OE NUMBER
	3304, 3306	2W8002 1727766			2P0661 1727775
		OR3007 4W0253 9Y4897 OR1013		Caterpillar L6 14.6L(893) 3406B,3406C "Engrane Plano", Freightliner, Ken worth, Volvo, White (Aplicacio nes automotrices) (1993-99)	7C4957 OR8217 10R0482 7W7019
	Caterpillar 6L (893) 3406E, "Engrane Campana", Frei ghtliner, Kenworth, (20 00-04)	613890 OR8218E 613890 OR4120 1OR0483		3406E C15	4N8734 4N0733
	3306	61343		3304 3306	611346



# INTERNATIONAL NAVI STAR

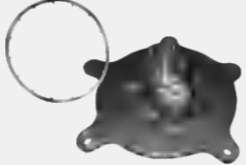



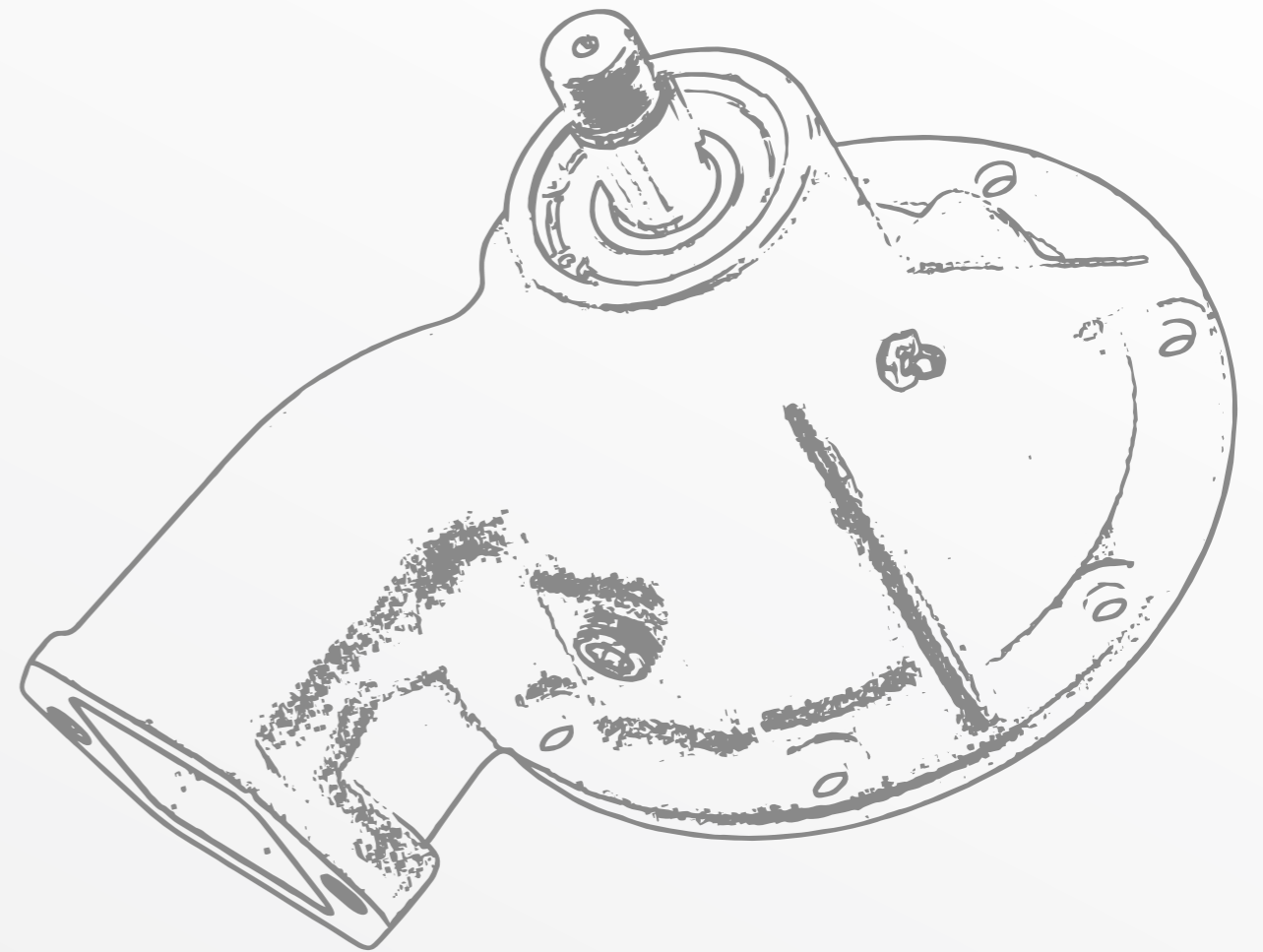

## WATER PUMP / WASSERPUMPEN

	ENGINE	OE NUMBER		ENGINE	OE NUMBER
	DT 466	685155C91 685155C92 685155C94 685155C95 735327C91 P-476D		DT 360/414/415 /466 DTA 360	1815538C91 735445C91 ZGA735327 P-476I
	DT 360/466	1817687C92 1817687C94 1817687C95 1817687C97 18179687C94 18179687C96 1821935C1 1821935C3 1830606C93		DT 466 DT 466E	1842664C92
	Maxx Force13	7091873C1 3007644C94			7081213C92 1886066C2



# MACK

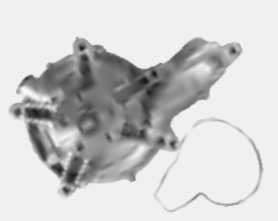



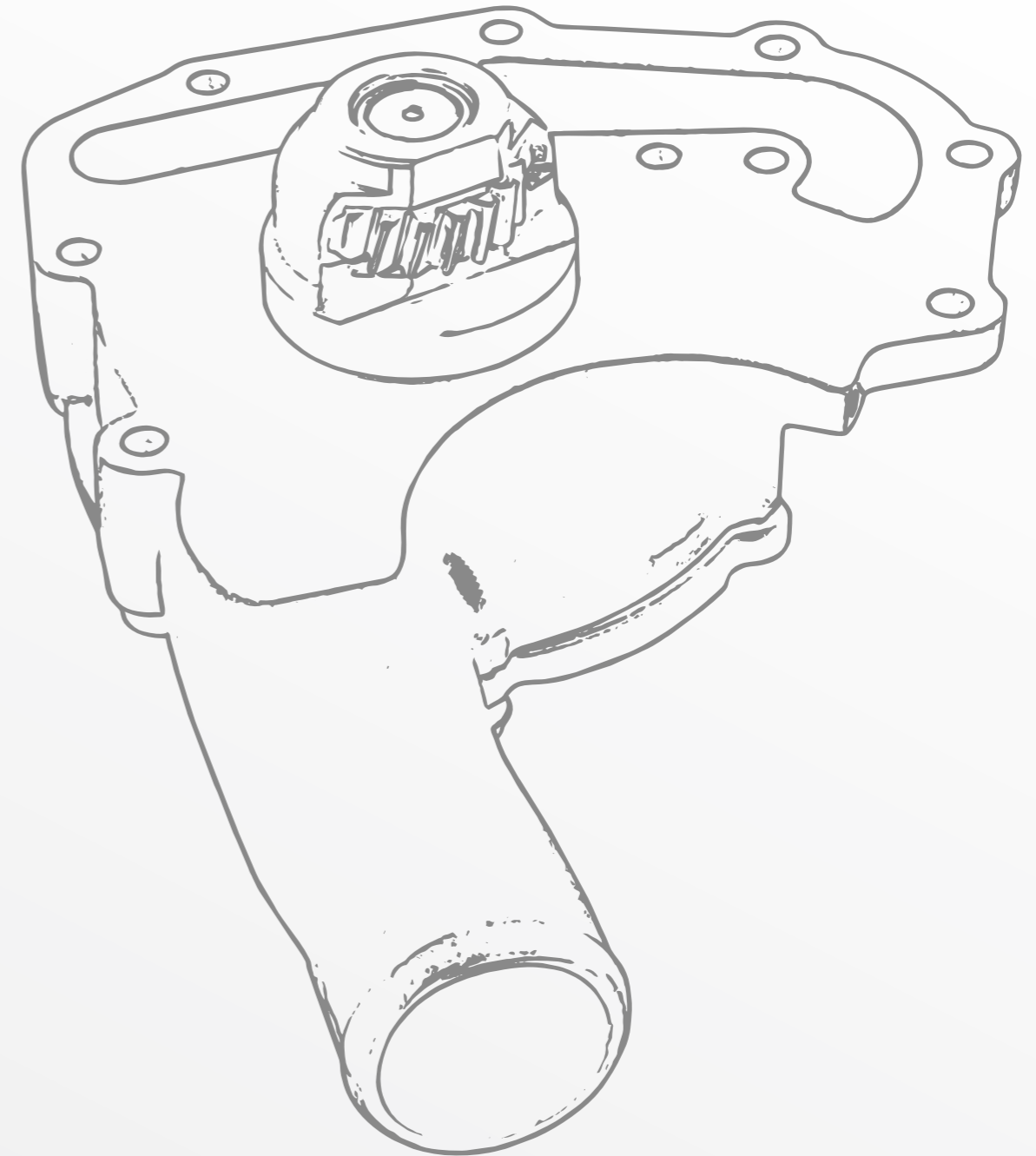





## WATER PUMP / WASSERPUMPEN

	ENGINE	OE NUMBER		ENGINE	OE NUMBER
	ENDT 675/676	316GC1184J		LE,MR, 6-11.9L	316GC3195
	L6			L6	316GC284A
		5001875237		MP8	2053845 20744939 21468471 21228793 85000486 20761306
		7485003149			











# PERKINS



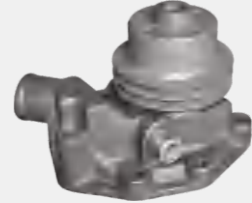

## WATER PUMP / WASSERPUMPEN

	ENGINE	OE NUMBER		ENGINE	OE NUMBER
	PHSAER 90	3771004/7		TURBO 900	
				6.354.4 A6.354.4 T6.354.4 6.372.4 A6.372.4	41313065 U5MW0129
	MOTER 4.236	41313201 41312143 41313237 41312201 41312323 U5MW0108 M743064			37773799
	MOTOR 4.203, 4.248,1.236 MASSY FURG USON Mfl65	41312167 41312063 41312574 U5MW0061			413A062 U5MW00194 U5MW0206
				Perkins L9 6 354(5.8L) (19 68-92) Dina Fase II, 531 Ford F600, GM C50, C60, New Holland Tractor.	U5MW0111 P105

## WATER PUMP / WASSERPUMPEN

	ENGINE	OE NUMBER		ENGINE	OE NUMBER
		41312784			41312154 41312159 41312487
		41312154 41312159 41312487			U5MW0193
		145017951			49875001
	C6.6	3544754			
		4131A113			U45010062





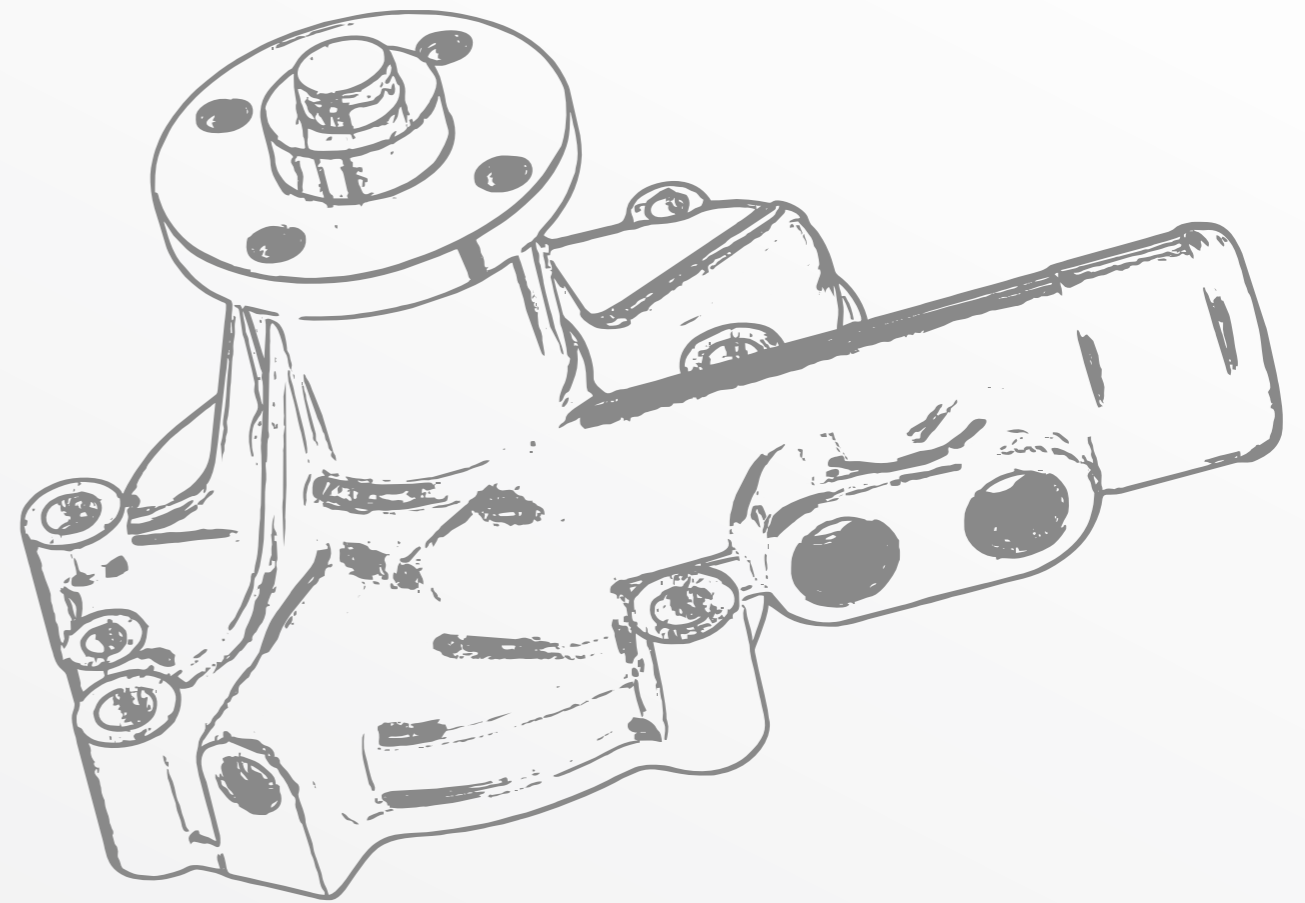





## WATER PUMP / WASSERPUMPEN

	ENGINE	OE NUMBER		ENGINE	OE NUMBER
		U45011030			
		4131A068			4854834
		T41321			













**OTHERS**







## WATER PUMP / WASSERPUMPEN

	ENGINE	OE NUMBER		ENGINE	OE NUMBER
	Single-sided Impeller	RE505980		Double-sided Impeller	
					
	6D95L	6209-61-1100		S6D95	6206-61-1100
	6D16T	ME995307		6D24	ME158623
	4TNV98	12990042050 12990042055		4JG1	8-94140341-1

## WATER PUMP / WASSERPUMPEN

	ENGINE	OE NUMBER		ENGINE	OE NUMBER
	6D108 8 Groove	6222631200		SK130-8	VA32G4521010
	6D108 4 Groove	6221611102		6D22 Engine oil	ME150295
	EX300-5	1-13650068-1		4JJ1 EX	8980228220
	4JJ1 SH	8980476893		4TN94 4TN94E	
		6506500-6139C			S00009382

## WATER PUMP / WASSERPUMPEN

	ENGINE	OE NUMBER		ENGINE	OE NUMBER
		S00009383			
					21828721
		ME075132 ME996811 ME993839 ME993455 ME075132			ME075293 ME075218

# Touch-Rich