

» 企业使命
Business Mission

打造车内舒适温度，弘扬华夏工匠风采。
Create a comfortable temperature inside the car and promote the demeanor of Chinese craftsmen.

» 企业愿景
Business Vision

做世界车用空调领先者，创康普瑞&康普瑞森百年品牌。
To be the world leader in car air conditioners and create a century-old brand of KPRUI&KPRS.

» 企业价值观
Business Values

担当 奋斗 奉献 分享 传承
Responsibility struggle dedication share inherited.



在乎舒适、可靠、节能，就用康普瑞&康普瑞森压缩机

产品图册
PRODUCT CATALOGUE

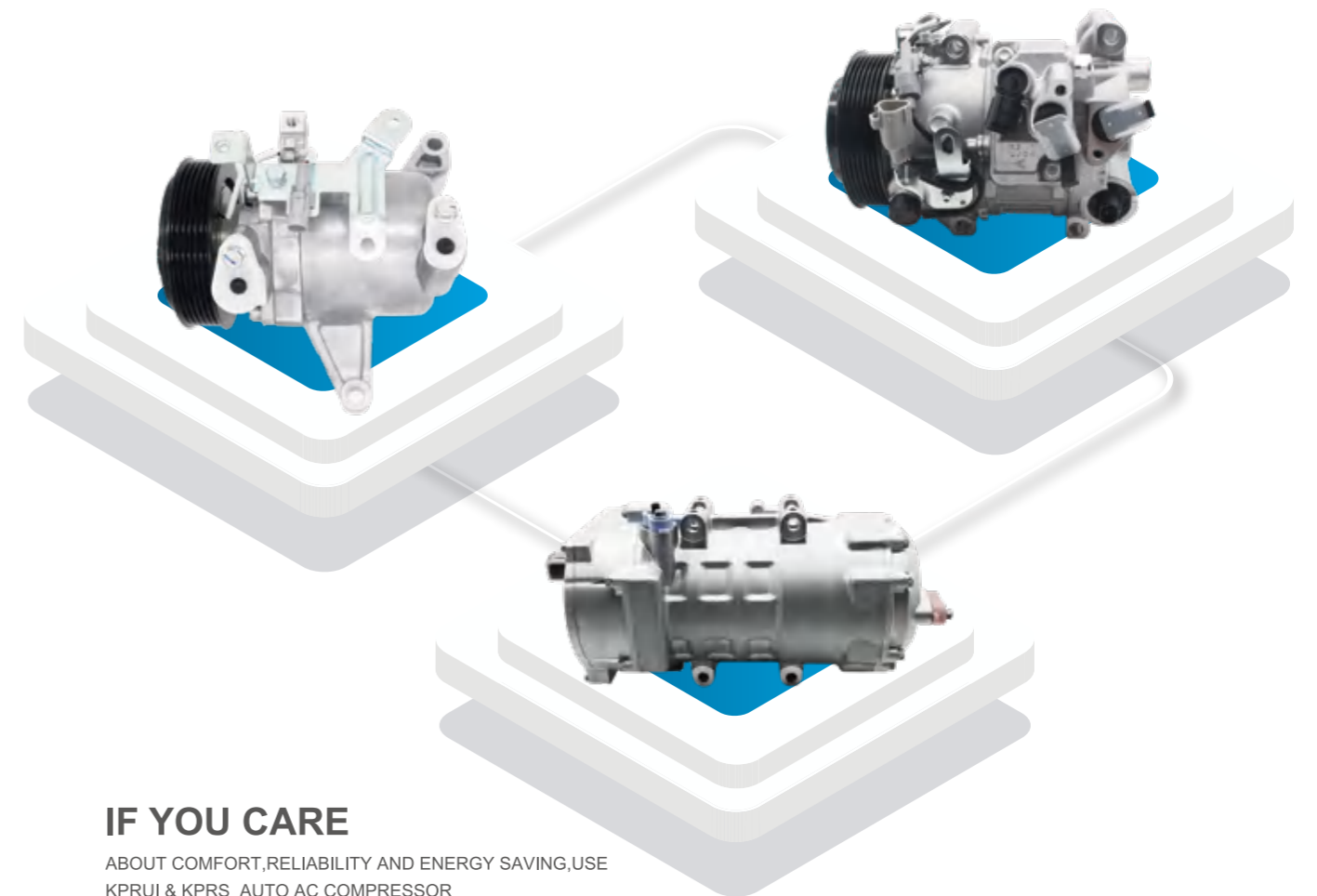

IF YOU CARE

ABOUT COMFORT,RELIABILITY AND ENERGY SAVING,USE
KPRUI & KPRS AUTO AC COMPRESSOR

常州康普瑞汽车空调有限公司&江苏康普瑞森新能源科技有限公司
CHANGZHOU KPRUI AUTOMOTIVE AIR-CONDITIONER CO.,LTD&JIANGSU KPRS NEW ENERGY TECHNOLOGY CO.,LTD

地址:江苏省常州市武进区牛溪路18号
Add: No.18 Niuxi Road, Wujin District, Changzhou City, Jiangsu Province, China
电话(Tel): 400 8282 835 邮箱(E-mail): zgj@kaac.com.cn/flynn@kaac.com.cn
手机(Mobile):18168826755/13151272808 网站(Website): www.kprui.com/www.jskprs.com

发布时间: 2025年11月 Release time: November 2025



江苏康普瑞森新能源科技有限公司
JIANGSU KPRS NEW ENERGY TECHNOLOGY CO.,LTD

常州康普瑞汽车空调有限公司
CHANGZHOU KPRUI AUTOMOTIVE AIR-CONDITIONER CO.,LTD

CONTENTS

- 1-8 | **公司介绍**
COMPANY PROFILE
- 9-12 | **农机系列**
AGRICULTURAL MACHINERY SERIES SELECTION MODELS
- 13-18 | **奥迪系列**
AUDI SERIES SELECTION MODELS
- 19-20 | **北汽系列**
BAIC SERIES SELECTION MODELS
- 21-30 | **奔驰系列**
BENZ SERIES SELECTION MODELS
- 31-34 | **宝马系列**
BMW SERIES SELECTION MODELS
- 35-36 | **华晨系列**
BRILLIANCE SERIES SELECTION MODELS
- 37-42 | **别克雪佛兰系列**
BUICK&CHEVROLET SERIES SELECTION MODELS
- 43-50 | **长安系列**
CHANGAN SERIES SELECTION MODELS
- 51-54 | **东风系列**
DONGFENG SERIES SELECTION MODELS
- 55-64 | **工程车、卡车系列**
ENGINEERING VEHICLE, TRUCK SERIES SELECTION MODELS
- 65-68 | **福特、重汽系列**
FORD&CNHTC SERIES SELECTION MODELS
- 69-72 | **广汽、吉利系列**
GAC GEELY SERIES SELECTION MODELS
- 73-76 | **长城系列**
GWM SERIES SELECTION MODELS
- 77-82 | **本田系列**
HONDA SERIES SELECTION MODELS
- 83-86 | **现代起亚系列**
HYUNDAI/ KIA SERIES SELECTION MODELS
- 87-88 | **五十铃系列**
ISUZU SERIES SELECTION MODELS
- 89-90 | **江淮系列**
JAC SERIES SELECTION MODELS
- 91-94 | **马自达系列**
MAZDA SERIES SELECTION MODELS
- 95-98 | **三菱系列**
MITSUBISHI SERIES SELECTION MODELS
- 99-104 | **日产系列**
NISSAN SERIES SELECTION MODELS
- 105-112 | **其他系列**
OTHER SERIES SELECTION MODELS
- 113-116 | **标致系列**
PEUGEOT SERIES SELECTION MODELS
- 117-126 | **冷藏系列**
REFRIGERATED SERIES SELECTION MODELS
- 127-130 | **雷诺系列**
RENAULT SERIES SELECTION MODELS
- 131-134 | **斯巴鲁系列**
SUBARU SERIES SELECTION MODELS
- 135-140 | **铃木系列**
SUZUKI SERIES SELECTION MODELS
- 141-148 | **丰田系列**
TOYOTA SERIES SELECTION MODELS
- 149-158 | **双向活塞系列**
TWO WAY SERIES SELECTION MODELS
- 159-162 | **大众系列**
VOLKSWAGEN SERIES SELECTION MODELS
- 163-164 | **五菱系列**
WULING SERIES SELECTION MODELS
- 165-168 | **新能源系列**
NEW ENERGY SERIES MODELS



关于我们

ABOUT US

500 +

现有职工人数(人)
The number of current employees exceeds (people)

57000 +

公司建筑面积(m²)
Company floor area (m²)

360万 +

年产能(台)
Estimated capacity (pcs)

集团公司成立于2006年,坐落于常州市武进区,是集研发、制造、销售、服务为一体的车用压缩机制造厂家。

Group company was founded in 2006, is located in Changzhou Wujin District, is a research and development, manufacturing, sales, service as one of the automotive air conditioning compressor manufacturers.

四大核心产品 FOUR CORE PRODUCTS

旋叶式压缩机

ROTARY VANE TYPE COMPRESSOR



活塞式压缩机

PISTON TYPE COMPRESSOR



涡旋式新能源电动压缩机

SCROLL TYPE ELECTRIC AC COMPRESSOR



精密铝压铸

PRECISION ALUMINUM DIE CASTING

公司荣誉 HONOR QUALIFICATION



CNAS认证
CNAS certification



国家级高新技术企业
National high-tech industry



国家级专精特新“小巨人”企业
National specialized special new small giant enterprise

江苏省互联网标杆工厂
Jiangsu Internet benchmarking factory

江苏省智能制造示范工厂
Jiangsu Provincial Smart Manufacturing Demonstration Factory

公司自有产业链

COMPANY-OWNED INDUSTRIAL CHAIN

精密铝压铸
Precision aluminum die casting



精密加工
Precision machining



实验
Experiment



装配
Assembly



发展历程

DEVELOPMENT PROCESS



● **2006年**
常州康普瑞汽车空调有限公司成立
KPRUI established

● **2013年**
车用空调压缩机与国内各大主机厂配套
新能源车用压缩机项目正式启动
Car air conditioning compressors are matched with major domestic Oems
The new energy compressor project was officially launched

● **2014-2015年**
荣获“国家高新技术企业”
导入丰田管理模式，开始精益改革
启动智能车间建设
Obtain “National high-tech enterprise technology”
Introduce Toyota management model and start lean reform
Start the construction of intelligent workshop

● **2009年**
车用空调压缩机上市
Automotive AC compressors on sale

● **2017年**
荣获“江苏省工程技术研究中心”
成立江苏普斯森精密机械有限公司
Obtain “Jiangsu Engineering Technology Research Center”
PUSSEN established

● **2019年**
成立江苏康普瑞森新能源科技有限公司
KPRS established

● **2020-2021年**
荣获“江苏省示范智能车间”
荣获“江苏省互联网标杆工厂”
荣获“江苏省‘小巨人’企业”
荣获“江苏省五星级上云企业”
两化融合AA级企业贯标升级认证
Obtain “Jiangsu Province demonstration intelligent workshop”
Obtain “Jiangsu Internet benchmarking factory”
Obtain “Jiangsu little giant enterprise”
Obtain “Jiangsu five-star cloud enterprise”
The integration of the two AA level enterprise standard upgrade certification

● **2022年**
荣获“国家级专精特新‘小巨人’企业”
荣获“江苏省智能制造示范工厂”
Obtain “National specialized special new small giant enterprise”
Obtain “Jiangsu Provincial Smart Manufacturing Demonstration Factory”

● **2023年**
通过CNAS认证
CNAS certification

● **2025年**
新工厂建成
New factory establish

公司荣誉

HONOR QUALIFICATION

130+
已获得国家专利
National patents
have been obtained

5
已获得体系证书
System
Certificate



公司荣获国家级专精特新“小巨人”企业、国家高新技术企业、江苏省工程技术研究中心、江苏省互联网标杆工厂、江苏省智能制造示范工厂等资质荣誉。

未来将继续坚持绿色低碳发展理念，不断开发创新，打造智能化绿色工厂。

The company has won National Specialized and Special New "Little Giant" Enterprise, National High-tech Enterprises, Jiangsu Engineering and Technology Research Center, Jiangsu Internet Benchmarking Factory, Jiangsu Demonstration Intelligent Workshop and other qualifications and honors.

In the future, we will continue to adhere to the concept of green and low-carbon development, constantly innovate and develop, and build intelligent green factories.



▼ 旋叶压缩机 ROTARY VANE COMPRESSOR

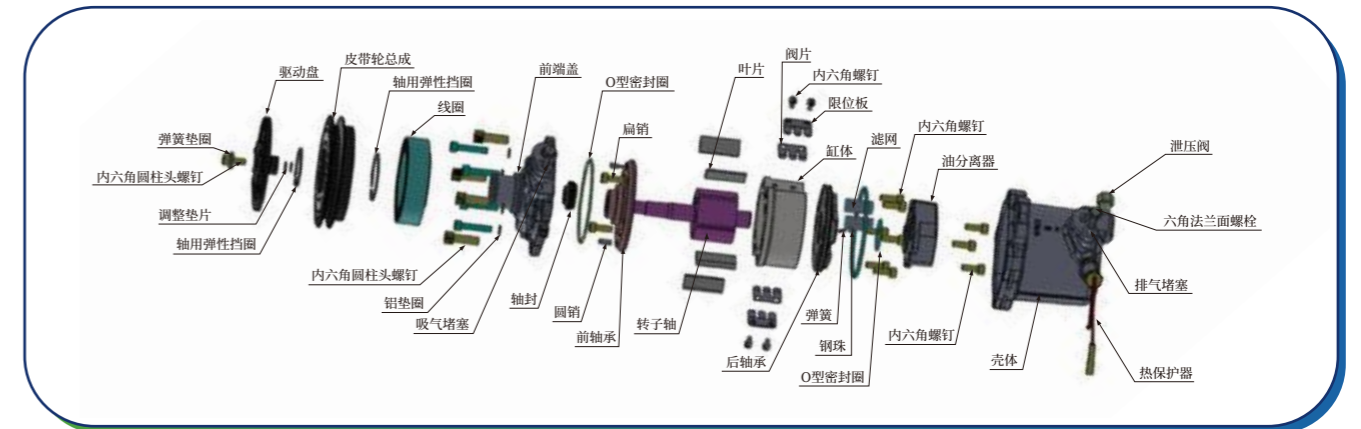

▼ 电动压缩机 ELECTRIC COMPRESSOR

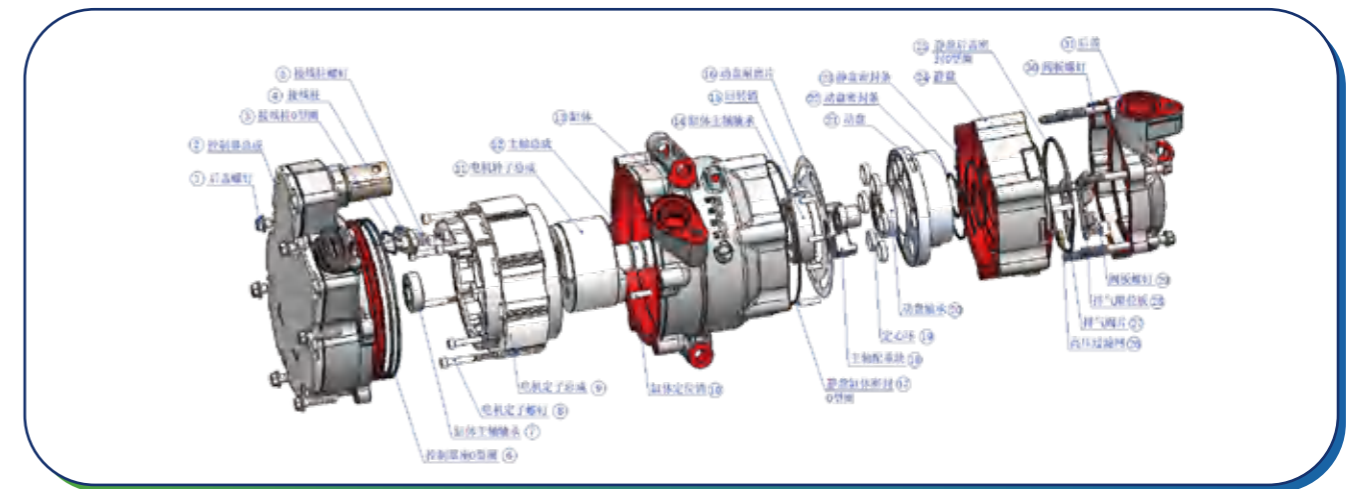

▼ 活塞压缩机 PISTON COMPRESSOR

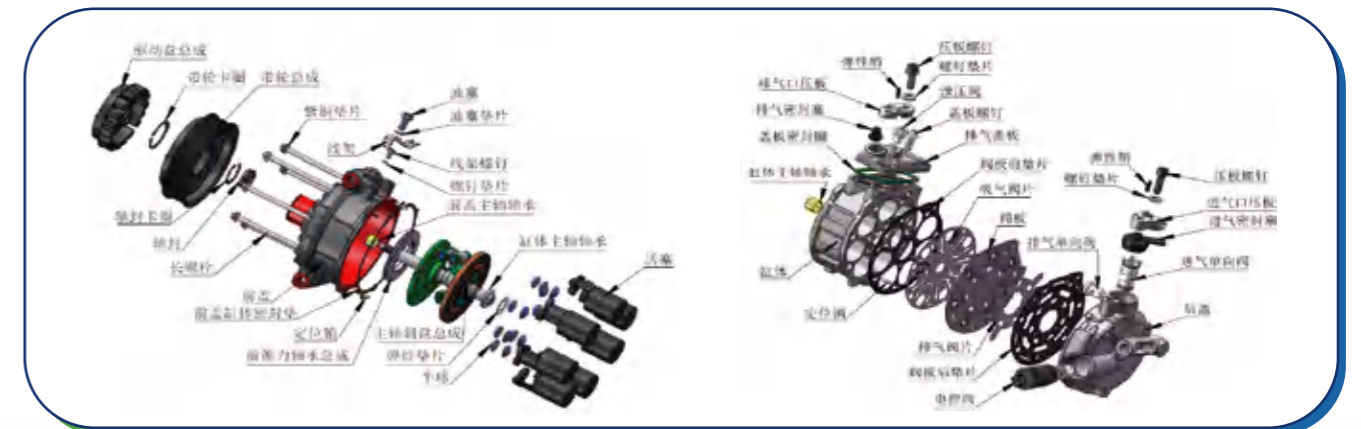

研发优势

R&D ADVANTAGES

研发团队 R&D TEAM

研发中心拥有一支在车用压缩机领域经验丰富的研发团队，具备极强的研发创新能力与拼搏奋斗精神。

The R & D center has an experienced team in the field of automotive AC compressors, with strong innovation ability and hard-working spirit.

汽车空调压缩机研发团队 AUTOMOTIVE AC COMPRESSOR R&D TEAM

研发人员(名) R&D PERSONNEL	高级工程师(名) SENIOR ENGINEER	新能源团队(名) NEW ENERGY TEAM
80+	6	30+

新能源研发团队 NEW ENERGY RESEARCH AND DEVELOPMENT TEAM

◎ 外聘专家 External expert	◎ 高级工程师 Senior engineer
◎ 高级软件工程师 Senior software engineer	◎ 结构工程师 Structural engineer
◎ 电子软件工程师 Electronic software engineer	◎ 产品设计师 Product designer

实验检测能力

TESTING AND INSPECTION CAPABILITIES



公司实验室2023年已获得国家CNAS资质，能够完成产品性能试验、耐久试验、噪声试验、振动试验、实车试验及力学试验等实验项目，对产品研发的全过程提供实验支撑。

The company's laboratory has obtained national CNAS qualification accreditation in 2023 and can independently complete experimental projects such as product performance testing, durability testing, noise testing, vibration testing, real vehicle testing and mechanical testing and can provide experimental support for the entire process of product development.

公司已通过 IATF - 16949 体系认证，运用高端检测设备为来料、生产过程及零件质量提供有效保证，确保交付优质产品。

The company has passed IATF-16949 system certification, the use of high-end testing equipment for incoming materials, production process and parts quality to provide effective assurance, to ensure the delivery of quality products.



德国蔡司三坐标 Carl Zeiss AG Three-coordinate measuring machine



农机系列 选用型号

AGRICULTURAL MACHINERY SERIES
SELECTION MODEL



在乎舒适、可靠、节能，就用康普瑞 & 康普瑞森压缩机



KPRS511001003

- 适用车型/Applicable Vehicle: 通用型、上出口
UNIVERSAL VERSION Upper exit
- 编号/Code: KPRS-5S11
- OE: /
- 皮带轮/Pulley: PV8/119
- 电压/Voltage: 12V
- 排量/Displacement: 108cc



KPRS511001001

- 适用车型/Applicable Vehicle: 通用型、上出口
UNIVERSAL VERSION Upper exit
- 编号/Code: KPRS-5S11
- OE: /
- 皮带轮/Pulley: A2/125
- 电压/Voltage: 12V
- 排量/Displacement: 108cc



KPRS511001004

- 适用车型/Applicable Vehicle: 通用型、上出口
UNIVERSAL VERSION Upper exit
- 编号/Code: KPRS-5S11
- OE: /
- 皮带轮/Pulley: PV8/119
- 电压/Voltage: 24V
- 排量/Displacement: 108cc



KPRS511008002

- 适用车型/Applicable Vehicle: 通用型、上出口
UNIVERSAL VERSION Upper exit
- 编号/Code: KPRS-5S11
- OE: /
- 皮带轮/Pulley: A2/125
- 电压/Voltage: 24V
- 排量/Displacement: 108cc



KPRS511008001

- 适用车型/Applicable Vehicle: 通用型、上出口
UNIVERSAL VERSION Upper exit
- 编号/Code: KPRS-5S11
- OE: /
- 皮带轮/Pulley: A2/125
- 电压/Voltage: 12V
- 排量/Displacement: 108cc



KPRS514001012

- 适用车型/Applicable Vehicle: 常发农装
Changfa
- 编号/Code: KPRS-5S14
- OE: /
- 皮带轮/Pulley: A2/170
- 电压/Voltage: 12V
- 排量/Displacement: 138cc



KPRS514001031

- 适用车型/Applicable Vehicle: 常发农装
Changfa
- 编号/Code: KPRS-5S14
- OE: /
- 皮带轮/Pulley: A2/170
- 电压/Voltage: 24V
- 排量/Displacement: 138cc



KPRS514001035

- 适用车型/Applicable Vehicle: 常发农装
Changfa
- 编号/Code: KPRS-5S14
- OE: /
- 皮带轮/Pulley: A2/200
- 电压/Voltage: 24V
- 排量/Displacement: 138cc



KPRS514002001

- 适用车型/Applicable Vehicle: 通用型、后出口
UNIVERSAL VERSION Rear Exit
- 编号/Code: KPRS-5S14
- OE: SD5S14-6631
- 皮带轮/Pulley: A2/132
- 电压/Voltage: 12V
- 排量/Displacement: 138cc



KPRS514002018

- 适用车型/Applicable Vehicle: 通用型/普通口后出
Universal type/normal back exit
- 编号/Code: KPRS-5S14
- OE: SD6628
- 皮带轮/Pulley: PV8/119
- 电压/Voltage: 12V
- 排量/Displacement: 138cc



KPRS514001001

- 适用车型/Applicable Vehicle: 通用型、上出口
UNIVERSAL VERSION Upper exit
- 编号/Code: KPRS-5S14
- OE: SD6626
- 皮带轮/Pulley: A2/132
- 电压/Voltage: 12V
- 排量/Displacement: 138cc



KPRS514006001

- 适用车型/Applicable Vehicle: 通用型、上出口
UNIVERSAL VERSION Upper exit
- 编号/Code: KPRS-5S14
- OE: /
- 皮带轮/Pulley: A2/132
- 电压/Voltage: 12V
- 排量/Displacement: 138cc



KPRS514003088

- 适用车型/Applicable Vehicle: 东方红拖拉机
Dongfanghong Tractor
- 编号/Code: KPRS-5S14
- OE: /
- 皮带轮/Pulley: A2/132
- 电压/Voltage: 12V
- 排量/Displacement: 138cc



KPRS514005093

- 适用车型/Applicable Vehicle: 通用型、上压板
UPPER PRESSURE PLATE
- 编号/Code: KPRS-5S14
- OE: /
- 皮带轮/Pulley: A2/132
- 电压/Voltage: 12V
- 排量/Displacement: 138cc



KPRS514009075

- 适用车型/Applicable Vehicle: 通用型、上出口
UNIVERSAL VERSION Upper exit
- 编号/Code: KPRS-5S14
- OE: /
- 皮带轮/Pulley: A2/170
- 电压/Voltage: 24V
- 排量/Displacement: 138cc



KPRS514007022

- 适用车型/Applicable Vehicle: 通用型、环保口
UNIVERSAL VERSION ECO EXIT
- 编号/Code: KPRS-5S14
- OE: /
- 皮带轮/Pulley: A2/132
- 电压/Voltage: 12V
- 排量/Displacement: 138cc



KPRS514012019

- 适用车型/Applicable Vehicle: 通用型、环保口
UNIVERSAL VERSION Eco Exit
- 编号/Code: KPRS-5S14
- OE: /
- 皮带轮/Pulley: A2/132
- 电压/Voltage: 24V
- 排量/Displacement: 138cc



KPRS514001074

- 适用车型/Applicable Vehicle: 常发农装
Changfa
- 编号/Code: KPRS-5S14
- OE: /
- 皮带轮/Pulley: A2/200
- 电压/Voltage: 12V
- 排量/Displacement: 138cc



KPRS514037085

- 适用车型/Applicable Vehicle: 云内
YUNNEI
- 编号/Code: KPRS-5S14
- OE: /
- 皮带轮/Pulley: PV8/119
- 电压/Voltage: 12V
- 排量/Displacement: 138cc



KPRS514058021

- 适用车型/Applicable Vehicle: 五征农机
Wuzheng
- 编号/Code: KPRS-5S14
- OE: /
- 皮带轮/Pulley: A2/132
- 电压/Voltage: 12V
- 排量/Displacement: 138cc



KPRS514036050

- 适用车型/Applicable Vehicle: 通用型、上压板
UNIVERSAL VERSION Upper plate
- 编号/Code: KPRS-5S14
- OE: /
- 皮带轮/Pulley: A2/132
- 电压/Voltage: 24V
- 排量/Displacement: 138cc



KPRS514001018

- 适用车型/Applicable Vehicle: 通用型、上出口
UNIVERSAL VERSION Upper plate
- 编号/Code: KPRS-5S14
- OE: /
- 皮带轮/Pulley: PV8/119
- 电压/Voltage: 12V
- 排量/Displacement: 138cc



KPRS514003093

- 适用车型/Applicable Vehicle: 通用型、上出口
UNIVERSAL VERSION Upper plate
- 编号/Code: KPRS-5S14
- OE: /
- 皮带轮/Pulley: A2/132
- 电压/Voltage: 12V
- 排量/Displacement: 138cc



KPRS715040046

- 适用车型/Applicable Vehicle: 东方红拖拉机
Dongfanghong Tractor
- 编号/Code: KPRS-7H15
- OE: 1402081R
- 皮带轮/Pulley: PV8/119
- 电压/Voltage: 12V
- 排量/Displacement: 155cc



KPR-96140

- 适用车型/Applications: 农机专用
SPECIAL FOR AGRICULTURAL MACHINERY
- OE: /
- 皮带轮/Pulley: A1/115.8
- 电压/Voltage: 12V



KPR-96183

- 适用车型/Applications: 东风农机
DONGFENG AGRICULTURAL MACHINERY
- OE: /
- 皮带轮/Pulley: A1/115.8
- 电压/Voltage: 12V

产品介绍

Product Introduction



奥迪系列

选用型号

AUDI SERIES SELECTION MODEL



在乎舒适、可靠、节能，就用康普瑞 & 康普瑞森压缩机



KPRS613003004

- 适用车型/Applicable Vehicle: 奥迪Q5 2.0/AUDI Q5 2.0
- 编号/Code: KPRS-6SE13
- OE: 5Q0820803K
- 皮带轮/Pulley: PV6/110
- 电压/Voltage: 12V
- 排量/Displacement: 133cc



KPRS613004039

- 适用车型/Applicable Vehicle: 奥迪C7/AUDI C7
- 编号/Code: KPRS-6SE13
- OE: 3Q0816803B
- 皮带轮/Pulley: PV6/110
- 电压/Voltage: 12V
- 排量/Displacement: 133cc



KPRS613007014

- 适用车型/Applicable Vehicle: 奥迪A4 B9 8W/奥迪A6 C7 4G 3.0TDI A4 B9 8W A6 C7 4G 3.0TDI
- 编号/Code: KPRS-6SE13
- OE: 4M0820803L/4M0816803L/4M0820803A
- 皮带轮/Pulley: PV6/110
- 电压/Voltage: 12V
- 排量/Displacement: 133cc



KPRS613044018

- 适用车型/Applicable Vehicle: AUDI A1 (8X1, 8XK)
- 编号/Code: KPRS-6SE13
- OE: 1K0820803E
- 皮带轮/Pulley: PV6/110
- 电压/Voltage: 12V
- 排量/Displacement: 133cc



KPRS613004008

- 适用车型/Applicable Vehicle: 奥迪 17-23款 A5/S5 2.0T AUDI A5/S5 2.0T 2017-2023
- 编号/Code: KPRS-6SE13
- OE: 8W0816803L
- 皮带轮/Pulley: PV6/125
- 电压/Voltage: 12V
- 排量/Displacement: 133cc



KPRS717080080

- 适用车型/Applicable Vehicle: 奥迪 19款 A8 3.0T AUDI A8 3.0T 2019
- 编号/Code: KPRS-7SE17
- OE: 447140-8311
- 皮带轮/Pulley: PV4/120
- 电压/Voltage: 12V
- 排量/Displacement: 170.5cc



KPRS717080041

- 适用车型/Applicable Vehicle: 奥迪 22款 Q7 3.0T AUDI Q7 3.0T 2022
- 编号/Code: KPRS-7SE17
- OE: 4M0820803F
- 皮带轮/Pulley: PV4/125
- 电压/Voltage: 12V
- 排量/Displacement: 170.5cc



KPRS613002002

- 适用车型/Applicable Vehicle: 20款奥迪Q5L 2020 AUDI Q5L
- 型号/Model: KPRS-6SE13
- OE: 8W0816803J
- 皮带轮/Pulley: PV6/125
- 电压/Voltage: 12V
- 排量/Displacement: 133cc



KPRS613039039

- 适用车型/Applicable Vehicle: 19-24款奥迪C7/19-23款Q3 1.4T 2019-2024 AUDI C7/2019-2023 Q3 1.4T
- 型号/Model: KPRS-6SE13
- OE: 3Q0816803D
- 皮带轮/Pulley: PV6/110
- 电压/Voltage: 12V
- 排量/Displacement: 133cc



KPRS613001001

- 适用车型/Applicable Vehicle: 奥迪C6/奥迪A6 2.0T
AUDI C6/AUDI A6 2.0T
- 型号/Model:KPRS-6SE13
- OE:64509145351
- 皮带轮/Pulley:PV6/100
- 电压/Voltage:12V
- 排量/Displacement:133cc



KPRS613001002

- 适用车型/Applicable Vehicle: 奥迪C6/奥迪A6 2.4/奥迪A8 3.0T
AUDI C6/AUDI A6 2.4
AUDI A8 3.0T
- 型号/Model:KPRS-6SE13
- OE:4F0260805AB
- 皮带轮/Pulley:PV6/125
- 电压/Voltage:12V
- 排量/Displacement:133cc



KPRS613001003

- 适用车型/Applicable Vehicle: 奥迪C6/奥迪A6 3.0T
AUDI C6/AUDI A6 3.0T
- 型号/Model:KPRS-6SE13
- OE:6450915682/2H6820803
- 皮带轮/Pulley:PV6/115
- 电压/Voltage:12V
- 排量/Displacement:133cc



KPRS613002001

- 适用车型/Applicable Vehicle: 奥迪A4L/奥迪Q5 (小轮)
AUDI A4L
AUDI Q5 (small wheel)
- 型号/Model:KPRS-6SE13
- OE:8K0260805L
- 皮带轮/Pulley:PV6/100
- 电压/Voltage:12V
- 排量/Displacement:133cc



KPRS613002018

- 适用车型/Applicable Vehicle: 奥迪A4L/奥迪Q5 (大轮)
AUDI A4L/ AUDI Q5 (big wheel)
- 型号/Model:KPRS-6SE13
- OE:8G0260805N
- 皮带轮/Pulley:PV6/110
- 电压/Voltage:12V
- 排量/Displacement:133cc



KPRS613004005

- 适用车型/Applicable Vehicle: 奥迪A7 2.0T/AUDI A7 2.0T
- 型号/Model:KPRS-6SE13
- OE:8T0260805F
- 皮带轮/Pulley:PV6/110
- 电压/Voltage:12V
- 排量/Displacement:133cc



KPRS613007009

- 适用车型/Applicable Vehicle: 2017款 奥迪A6L 2.5
2017 AUDI A6L 2.5
- 型号/Model:KPRS-6SE13
- OE:4GD820803M/4GD260805E
- 皮带轮/Pulley:PV6/125
- 电压/Voltage:12V
- 排量/Displacement:133cc



KPRS613007041

- 适用车型/Applicable Vehicle: 奥迪Q7/A6 C6 4.2/A4 S4 S5 3.0 TFSI
AUDI Q7/A6 C6 4.2/ A4 S4 S5 3.0 TFSI
- 型号/Model:KPRS-6SE13
- OE:8W0816803A
- 皮带轮/Pulley:PV4/125
- 电压/Voltage:12V
- 排量/Displacement:133cc



KPRS613007042

- 适用车型/Applicable Vehicle: 奥迪A4 A6 S4 S5 3.0混动
AUDI A4 A6 S4 S5 3.0 (Hybrid)
- 型号/Model:KPRS-6SE13
- OE:447140-3020
- 皮带轮/Pulley:PV4/110
- 电压/Voltage:12V
- 排量/Displacement:133cc



KPRS613019001

- 适用车型/Applicable Vehicle: 奥迪A4 2.0T/奥迪B7 1.8T
AUDI A4 2.0T/ AUDI B7 1.8T
- 型号/Model:KPRS-6SE13
- OE:8E0260805BA
- 皮带轮/Pulley:PV6/100
- 电压/Voltage:12V
- 排量/Displacement:133cc



KPRS613044044

- 适用车型/Applicable Vehicle: 奥迪RS3 2.5/奥迪TT 2016
AUDI RS3 2.5/AUDI TT 2016
- 型号/Model:KPRS-6SE13
- OE:8S0816803
- 皮带轮/Pulley:PV5/122
- 电压/Voltage:12V
- 排量/Displacement:133cc



KPRS717013002

- 适用车型/Applicable Vehicle: 奥迪Q7 3.0/AUDI Q7 3.0
- 型号/Model:KPRS-7SE17
- OE:7L6820808
- 皮带轮/Pulley:PV6/125
- 电压/Voltage:12V
- 排量/Displacement:170.5cc



KPRS717014021

- 适用车型/Applicable Vehicle: 奥迪A4/AUDI A4
- 型号/Model:KPRS-7SE17
- OE:4M0820803F
- 皮带轮/Pulley:PV4/110
- 电压/Voltage:12V
- 排量/Displacement:170.5cc



KPRS717023021

- 适用车型/Applicable Vehicle: 奥迪A6(4B,5C)/奥迪A(8E2,B6)
AUDI A6(4B,5C)/AUDI A(8E2,B6)
- 型号/Model:KPRS-7SE17
- OE:8E0260805AH
- 皮带轮/Pulley:PV4/110
- 电压/Voltage:12V
- 排量/Displacement:170.5cc



KPRS717039018

- 适用车型/Applicable Vehicle: 奥迪A4/AUDI A4
- 型号/Model:KPRS-7SE17
- OE:7L6820808
- 皮带轮/Pulley:PV6/110
- 电压/Voltage:12V
- 排量/Displacement:170.5cc



KPRS717046018

- 适用车型/Applicable Vehicle: 奥迪A3/AUDI A3
- 型号/Model:KPRS-7SE17
- OE:1K0820859F
- 皮带轮/Pulley:PV6/110
- 电压/Voltage:12V
- 排量/Displacement:170.5cc



KPRS717071071

- 适用车型/Applicable Vehicle: 奥迪Q7/卡宴3.6
AUDI Q7/Cayenne 3.6
- 型号/Model: KPRS-7SE17
- OE:7L6820803D
- 皮带轮/Pulley: PV7/110
- 电压/Voltage: 12V
- 排量/Displacement: 170.5cc



KPRS717071072

- 适用车型/Applicable Vehicle: 02款奥迪A8 3.7/4.2/6.0
2002 AUDI A8 3.7/4.2/6.0
- OE: 7L6820808
- 型号/Model: KPRS-7SE17
- 皮带轮/Pulley: PV7/120
- 电压/Voltage: 12V
- 排量/Displacement: 170.5cc



KPRS717071073

- **适用车型/Applicable Vehicle:**
07款奥迪(进口) A8 6.0L
2007 AUDI(import) A8 6.0L
- **型号/Model:** KPRS-7SE17
- **OE:** /
- **皮带轮/Pulley:** PV7/120
- **电压/Voltage:** 12V
- **排量/Displacement:** 170.5CC

产品介绍

Product Introduction



北汽系列

BAIC SELECTION MODEL

选用型号



在乎舒适、可靠、节能，就用康普瑞 & 康普瑞森压缩机



KPR-1128

- 适用车型/Applications: 比速T3 1.3T 2017
BLSUAUTO T3 1.3T 2017
- OE: /
- 皮带轮/Pulley: PV6/110
- 电压/Voltage: 12V



KPR-1129

- 适用车型/Applications: 北汽威望M20
BAIC WEIWANG M20
- OE: /
- 皮带轮/Pulley: PV4/100
- 电压/Voltage: 12V



KPR-1211

- 适用车型/Applications: 北汽福田迷笛
BAIC FOTON MIDI
- OE: /
- 皮带轮/Pulley: PV5/118
- 电压/Voltage: 12V



KPR-12108

- 适用车型/Applications: 北汽银翔H20
BAIC YINXIANG H20
- OE: /
- 皮带轮/Pulley: PV6/110
- 电压/Voltage: 12V



KPR-9676

- 适用车型/Applications: 北斗星(单槽)
BIG DIPPER STAR/SINGLE-GROOVE
- OE: /
- 皮带轮/Pulley: 单O槽/110
- 电压/Voltage: 12V

产品介绍

Product Introduction



奔驰系列

选用型号

BENZ SERIES SELECTION MODEL



在乎舒适、可靠、节能，就用康普瑞 & 康普瑞森压缩机



KPRS613008067

- 适用车型/Applicable Vehicle: 奔驰W213 S213/BENZ W213 S213
- 型号/Model:KPRS-6SE13
- OE:A0008301301
- 皮带轮/Pulley:PV5/115
- 电压/Voltage:12V
- 排量/Displacement:133cc



KPRS616016016

- 适用车型/Applicable Vehicle: 奔驰A180 (W176) 2012
- 型号/Model:KPRS-6SE13
- OE:A0008305702/A0038304360
- 皮带轮/Pulley:PV5/115
- 电压/Voltage:12V
- 排量/Displacement:160cc



KPRS714005005

- 适用车型/Applicable Vehicle: 奔驰卡车(方插)/BENZ TRUCK
- 型号/Model:KPRS-7SB17
- OE:A5412301311
- 皮带轮/Pulley:PV11/130
- 电压/Voltage:24V
- 排量/Displacement:170.5cc



KPRS714005008

- 适用车型/Applicable Vehicle: 奔驰E级 W210
- 型号/Model:KPRS-7SB17
- OE:0002306811
- 皮带轮/Pulley:PV6/120
- 电压/Voltage:24V
- 排量/Displacement:170.5cc



KPRS717019004

- 适用车型/Applicable Vehicle: 奔驰GL/GLS350 W166柴油7PK单控
- 型号/Model:KPRS-7SE17
- OE:A0008300201
- 皮带轮/Pulley:PV7/110
- 电压/Voltage:12V
- 排量/Displacement:170.5cc



KPRS717016005

- 适用车型/Applicable Vehicle: 奔驰C180K 2011/BENZ C180K 2011
- 型号/Model:KPRS-7SE17
- OE:A0002306211
- 皮带轮/Pulley:PV7/120
- 电压/Voltage:12V
- 排量/Displacement:170.5cc



KPRS717070070

- 适用车型/Applicable Vehicle: 奔驰AMG GT 4.0 2016
- 型号/Model:KPRS-7SE17
- OE:A1908302500/A1908304500
- 皮带轮/Pulley:18齿/104
- 电压/Voltage:12V
- 排量/Displacement:170.5cc



KPRS613008006

- 适用车型/Applicable Vehicle: 奔驰G350 D/Benz G350 D
- 编号/Code: KPRS613008006
- OE: A0008303500
- 皮带轮/Pulley: PV7/110
- 电压/Voltage: 12V
- 排量/Displacement: 133cc



KPRS613008045

- 适用车型/Applicable Vehicle: 16款奔驰E350(国外)
- 编号/Code: KPRS613008045
- OE: A0008300202
- 皮带轮/Pulley:PV7/120
- 电压/Voltage: 12V
- 排量/Displacement: 133CC



KPRS613005006

- 适用车型/Applicable Vehicle: 奔驰GLE/BENZ GLE
- 型号/Model: KPRS-6SE13
- OE: A0008305702/A0038304360
- 皮带轮/Pulley: PV5/115
- 电压/Voltage: 12V
- 排量/Displacement: 133cc



KPRS613006007

- 适用车型/Applicable Vehicle: 奔驰GLA/BENZ GLA
- 型号/Model: KPRS-6SE13
- OE: A0008303502/A0038304460
- 皮带轮/Pulley: PV5/115
- 电压/Voltage: 12V
- 排量/Displacement: 133cc



KPRS613008007

- 适用车型/Applicable Vehicle: 16款奔驰C级/BENZ GLC 2016C
- 型号/Model: KPRS-6SE13
- OE: A0008303002/A0008304400/A0032306911
- 皮带轮/Pulley: PV6/110
- 电压/Voltage: 12V
- 排量/Displacement: 133cc



KPRS616011011

- 适用车型/Applicable Vehicle: 奔驰AMG (W124, W210, W211, W212, W213, C207, W238)
- 型号/Model: KPRS-6SE16
- OE: A0022305111/A0022306511
- 皮带轮/Pulley: PV6/110
- 电压/Voltage: 12V
- 排量/Displacement: 160cc



KPRS616012012

- 适用车型/Applicable Vehicle: 奔驰GL350/BENZ GL350
- 型号/Model: KPRS-6SE16
- OE: A0032302911
- 皮带轮/Pulley: PV6/110
- 电压/Voltage: 12V
- 排量/Displacement: 160cc



KPRS616012029

- 适用车型/Applicable Vehicle: 奔驰GL350 3.0 C柴油2012
- 型号/Model: KPRS-6SE16
- OE: A0032306011
- 皮带轮/Pulley: PV7/110
- 电压/Voltage: 12V
- 排量/Displacement: 160cc



KPRS616013013

- 适用车型/Applicable Vehicle: 2015款奔驰GL350/2014款奔驰E350(国外)
- 型号/Model: KPRS-6SE16
- OE: A0008302100/A0008302500
- 皮带轮/Pulley: PV6/115
- 电压/Voltage: 12V
- 排量/Displacement: 160cc



KPRS616014014

- 适用车型/Applicable Vehicle: 奔驰A180 (W176) 奔驰B200 (W246)
- 型号/Model: KPRS-6SE16
- OE: A0042300311
- 皮带轮/Pulley: PV5/115
- 电压/Voltage: 12V
- 排量/Displacement: 160cc



KPRS616025011

- 适用车型/Applicable Vehicle: 奔驰E550 W212 4.6 E250
- 型号/Model: KPRS-6SE16
- OE: A0008307600/A0022303111/A0022309711
- 皮带轮/Pulley: PV6/110
- 电压/Voltage: 12V
- 排量/Displacement: 160cc



KPRS616025013

- 适用车型/Applicable Vehicle: 奔驰W212 E350
- 型号/Model: KPRS-6SE16
- OE: A0022307311
- 皮带轮/Pulley: PV6/115
- 电压/Voltage: 12V
- 排量/Displacement: 160cc



KPRS616026026

- 适用车型/Applicable Vehicle: 2012款奔驰E300/奔驰ML350 (三针)
- 型号/Model: KPRS-6SE16
- OE: A0008305100/A0008302600/A0008302700
- 皮带轮/Pulley: PV6/110
- 电压/Voltage: 12V
- 排量/Displacement: 160cc



KPRS616034034

- 适用车型/Applicable Vehicle: 奔驰R171 W203 W211
- 型号/Model: KPRS-6SE16
- OE: A0012308011
- 皮带轮/Pulley: PV7/120
- 电压/Voltage: 12V
- 排量/Displacement: 160cc



KPRS616036011

- 适用车型/Applicable Vehicle: 奔驰C200 C250 W204E200 E250 W212
- 型号/Model: KPRS-6SE16
- OE: A0032304811
- 皮带轮/Pulley: PV6/110
- 电压/Voltage: 12V
- 排量/Displacement: 160cc



KPRS616036034

- 适用车型/Applicable Vehicle: 奔驰W204 [2007-2015]
- 型号/Model: KPRS-6SE16
- OE: A0022303011
- 皮带轮/Pulley: PV7/120
- 电压/Voltage: 12V
- 排量/Displacement: 160cc



KPRS717001001

- 适用车型/Applicable Vehicle: 奔驰W203/奔驰W220(小轮)
- 型号/Model: KPRS-7SE17
- OE: 0012300211
- 皮带轮/Pulley: PV6/104
- 电压/Voltage: 12V
- 排量/Displacement: 170.5cc



KPRS717001002

- 适用车型/Applicable Vehicle: 奔驰S350/奔驰W203 (大轮)
- 型号/Model: KPRS-7SE17
- OE: 0002308011
- 皮带轮/Pulley: PV6/110
- 电压/Voltage: 12V
- 排量/Displacement: 170.5cc



KPRS717001003

- 适用车型/Applicable Vehicle: 奔驰W203/C320/奔驰W211/S211
- 型号/Model: KPRS-7SE17
- OE: 0012300111
- 皮带轮/Pulley: PV7/104
- 电压/Voltage: 12V
- 排量/Displacement: 170.5cc



KPRS717001004

- 适用车型/Applicable Vehicle: 奔驰S600/BENZ S600
- 型号/Model: KPRS-7SE17
- OE: 0012303211
- 皮带轮/Pulley: PV7/110
- 电压/Voltage: 12V
- 排量/Displacement: 170.5cc



KPRS717001005

- 适用车型/Applicable Vehicle:
奔驰W203 C180 2002-2007
BENZ W203 C180 2002-2007
- 型号/Model:KPRS-7SE17
- OE:0002309711
- 皮带轮/Pulley:PV7/120
- 电压/Voltage:12V
- 排量/Displacement:170.5cc



KPRS717001029

- 适用车型/Applicable Vehicle:
奔驰AMG SLK32
奔驰C32 3.2L V6 2002-2004
BENZ AMG SLK32
BENZ C32 3.2L V6 2002-2004
- 型号/Model:KPRS-7SE17
- OE:0002307811
- 皮带轮/Pulley:PV8/110
- 电压/Voltage:12V
- 排量/Displacement:170.5cc



KPRS717001040

- 适用车型/Applicable Vehicle:
奔驰W164 2005-2009
BENZ W164 2005-2009
- 型号/Model:KPRS-7SE17
- OE:0012308811
- 皮带轮/Pulley:PV8/104
- 电压/Voltage:12V
- 排量/Displacement:170.5cc



KPRS717001043

- 适用车型/Applicable Vehicle:
奔驰W211/BENZ W211
- 型号/Model:KPRS-7SE17
- OE:0012300111/A0008306000
- 皮带轮/Pulley:PV7/115
- 电压/Voltage:12V
- 排量/Displacement:170.5cc



KPRS717001050

- 适用车型/Applicable Vehicle:
奔驰 迈巴赫/BENZ MAYBACH
- 型号/Model:KPRS-7SE17
- OE:A0002308211
- 皮带轮/Pulley:PV10/104
- 电压/Voltage:12V
- 排量/Displacement:170.5cc



KPRS717001053

- 适用车型/Applicable Vehicle:
奔驰GLE 250 D/BENZ GLE 250 D
- 型号/Model:KPRS-7SE17
- OE:0022307511
- 皮带轮/Pulley:PV6/115
- 电压/Voltage:12V
- 排量/Displacement:170.5cc



KPRS717002006

- 适用车型/Applicable Vehicle:
奔驰 W222 350D 2016
BENZ W222 350D 2016
- 型号/Model:KPRS-7SE17
- OE:A0008307200
- 皮带轮/Pulley:PV7/110
- 电压/Voltage:12V
- 排量/Displacement:170.5cc



KPRS717002007

- 适用车型/Applicable Vehicle:
奔驰 GLE350 3.5L 2016-2018
BENZ GLE350 3.5L 2016-2018
- 型号/Model:KPRS-7SE17
- OE:A0008303702
- 皮带轮/Pulley:PV6/110
- 电压/Voltage:12V
- 排量/Displacement:170.5cc



KPRS717003002

- 适用车型/Applicable Vehicle:
奔驰GLE W166 AMG 2015-2019
BENZ GLE W166 AMG 2015-2019
- 型号/Model:KPRS-7SE17
- OE:A0008303501
- 皮带轮/Pulley:PV6/110
- 电压/Voltage:12V
- 排量/Displacement:170.5cc



KPRS717003003

- 适用车型/Applicable Vehicle:
奔驰 GLE 350D 2018
BENZ GLE 350D 2018
- 型号/Model:KPRS-7SE17
- OE:A0008303701/A0008306902/
GE447150-6063/447250-0242
- 皮带轮/Pulley:PV7/104
- 电压/Voltage:12V
- 排量/Displacement:170.5cc



KPRS717003004

- 适用车型/Applicable Vehicle:
奔驰GL350 柴油 3.0T X166
BENZ GL350 diesel fuel 3.0T X166
- 型号/Model:KPRS-7SE17
- OE:A0008309500
- 皮带轮/Pulley:PV7/110
- 电压/Voltage:12V
- 排量/Displacement:170.5cc



KPRS717015022

- 适用车型/Applicable Vehicle:
奔驰C63 AMG/BENZ C63 AMG
- 型号/Model:KPRS-7SE17
- OE:A0008300901
- 皮带轮/Pulley:PV4/110
- 电压/Voltage:12V
- 排量/Displacement:170.5cc



KPRS717016002

- 适用车型/Applicable Vehicle:
奔驰C200 2.0/BENZ C200 2.0
- 型号/Model:KPRS-7SE17
- OE:A0032304811
- 皮带轮/Pulley:PV6/110
- 电压/Voltage:12V
- 排量/Displacement:170.5cc



KPRS717019002

- 适用车型/Applicable Vehicle:
奔驰W166/BENZ W166
- 型号/Model:KPRS-7SE17
- OE:A0008309800
- 皮带轮/Pulley:PV6/110
- 电压/Voltage:12V
- 排量/Displacement:170.5cc



KPRS717040002

- 适用车型/Applicable Vehicle:
W221奔驰大轮 (双插针)
W221BENZ big wheel
(Double pins)
- 型号/Model:KPRS-7SE17
- OE:0022306211
- 皮带轮/Pulley:PV6/110
- 电压/Voltage:12V
- 排量/Displacement:170.5cc



KPRS717043011

- 适用车型/Applicable Vehicle:
W221奔驰大轮
W221BENZ big wheel
- 型号/Model:KPRS-7SE17
- OE:0022306211
- 皮带轮/Pulley:PV6/110
- 电压/Voltage:12V
- 排量/Displacement:170.5cc



KPRS717043025

- 适用车型/Applicable Vehicle:
奔驰小轮/BENZ small wheel
- 型号/Model:KPRS-7SE17
- OE:A0012301211
- 皮带轮/Pulley:PV6/100
- 电压/Voltage:12V
- 排量/Displacement:170.5cc



KPRS717044011

- 适用车型/Applicable Vehicle:
W221奔驰大轮 (双针)
W221 BENZ big wheel (Double pins)
- 型号/Model:KPRS-7SE17
- OE:A0022300911/A0022308011/
A0032309811
- 皮带轮/Pulley:PV6/110
- 电压/Voltage: 12V
- 排量/Displacement:170.5cc



KPRS717044025

- 适用车型/Applicable Vehicle:
奔驰小轮 (双针)
BENZ small wheel (Double pins)
- 型号/Model:KPRS-7SE17
- OE:A0022306711
- 皮带轮/Pulley:PV6/100
- 电压/Voltage:12V
- 排量/Displacement:170.5cc



KPRS717048029

- 适用车型/Applicable Vehicle:
奔驰S级 W222/BENE S W222
- 型号/Model:KPRS-7SE17
- OE:A0008306300
- 皮带轮/Pulley:PV7/110
- 电压/Voltage:12V
- 排量/Displacement:170.5cc



KPRS717048048

- 适用车型/Applicable Vehicle:
奔驰 (国外)
BENZ (foreign edition)
- 型号/Model:KPRS-7SE17
- OE:A0008302600
- 皮带轮/Pulley:PV6/110
- 电压/Voltage:12V
- 排量/Displacement:170.5cc



KPRS717063025

- 适用车型/Applicable Vehicle:
奔驰S550/S560 (国外)
Benz S550/S560(foreign edition)
- 编号/Code: KPRS717063025
- OE: A0008303501
- 皮带轮/Pulley: PV6/100
- 电压/Voltage: 12V
- 排量/Displacement: 170.5CC



KPR-6337

- 适用车型/Applications:
奔驰SMART
SMART FORFOUR W453 0.9
- OE: 926802090R/A45383070000
- 皮带轮/Pulley: PV7/100
- 电压/Voltage: 12V



KPR-8305

- 适用车型/Applications:
奔驰SMART
SMART CITY-COUPE (450)
[1998-2004/MERCEDES BENZ W168
- OE: 1602300011/A1602300011
- 皮带轮/Pulley: PV3/110
- 电压/Voltage: 12V



KPRS717061002

- 适用车型/Applicable Vehicle:
奔驰单控ML/奔驰GLS400
BENZ Single control ML
BENZ GLS400
- 型号/Model:KPRS-7SE17
- OE:A0008305502
- 皮带轮/Pulley:PV6/110
- 电压/Voltage:12V
- 排量/Displacement:170.5cc



KPRS717062007

- 适用车型/Applicable Vehicle:
奔驰双控ML
BENZ DUAL CONTROL ML
- 型号/Model:KPRS-7SE17
- OE:A0008303202
- 皮带轮/Pulley:PV6/110
- 电压/Voltage:12V
- 排量/Displacement:170.5cc



KPRS717063011

- 适用车型/Applicable Vehicle:
奔驰ML (单控) /2017
E550/2017-2018 CLS550
2017-2018 CLS63 AMG S
BENE ML (Single control) 2017
E550/2017-2018 CLS550
2017-2018 CLS63 AMG S
- 型号/Model:KPRS-7SE17
- OE:A0008307602
- 皮带轮/Pulley:PV6/110
- 电压/Voltage:12V
- 排量/Displacement:170.5cc



KPR-8319

- 适用车型/Applications:
奔驰SMART
SMART 'FORTWO II 1.0 07
- OE: A1322300011/ZGS004/
1322300011/92600YS000
SS96DLG2
- 皮带轮/Pulley: PV4/120
- 电压/Voltage: 12V



KPR-1418

- 适用车型/Applications:
北方奔驰 (双A槽)
BEIBEN TRUCK (DUAL A-GROOVE)
- OE: /
- 皮带轮/Pulley: A2/128
- 电压/Voltage: 24V



KPRS714005010

- 适用车型/Applicable Vehicle:
奔驰卡车 (方插PV9/24V)
BENZ TRUCK
- 型号/Model:KPRS-7SB17
- OE:5412300211
- 皮带轮/Pulley:PV9/130
- 电压/Voltage:24V
- 排量/Displacement:170.5cc



KPRS717067067

- 适用车型/Applicable Vehicle:
奔驰W223/V223(2020)
BENZ W223/V223(2020)
- 型号/Model:KPRS-7SE17
- OE:A0008301401
- 皮带轮/Pulley:PV5/115
- 电压/Voltage:12V
- 排量/Displacement:170.5cc



KPRS717068011

- 适用车型/Applicable Vehicle:
奔驰 W204 2.2/BENZ W204 2.2
- 型号/Model:KPRS-7SE17
- OE:A0022305011
- 皮带轮/Pulley:PV6/110
- 电压/Voltage:12V
- 排量/Displacement:170.5cc



KPRS717069022

- 适用车型/Applicable Vehicle:
奔驰18款S560/W222
BENZ 2018 S560/W222
- 型号/Model:KPRS-7SE17
- OE:A0008301401
- 皮带轮/Pulley:PV4/110
- 电压/Voltage:12V
- 排量/Displacement:170.5cc



KPRS717044044

- 适用车型/Applicable Vehicle:
奔驰07-14款W216/W221/S350/CL600
BENZ W216/w221/S350/CL600
2007-2014
- 型号/Model:KPRS-7SE17
- OE:A0022303211
- 皮带轮/Pulley:PV7/100
- 电压/Voltage:12V
- 排量/Displacement:170.5cc



KPRS714005006

- 适用车型/Applicable Vehicle:
奔驰卡车 (圆插PV9/12V)
BENZ TRUCK
- 型号/Model:KPRS-7SB17
- OE:/
- 皮带轮/Pulley:PV9/130
- 电压/Voltage:12V
- 排量/Displacement:170.5cc



KPRS714005007

- 适用车型/Applicable Vehicle:
奔驰卡车 (圆插PV11/24V)
BENZ TRUCK
- 型号/Model:KPRS-7SB17
- OE:4371007950
- 皮带轮/Pulley:PV11/130
- 电压/Voltage:24V
- 排量/Displacement:170.5cc



KPRS714005009

- 适用车型/Applicable Vehicle:
奔驰卡车 (方插PV9/12V)
BENZ TRUCK
- 型号/Model:KPRS-7SB17
- OE:A0002343711
- 皮带轮/Pulley:PV9/130
- 电压/Voltage:12V
- 排量/Displacement:170.5cc



KPRS616026027

- 适用车型/Applicable Vehicle:
奔驰13-14款 E350/ML350BEN
ZE350/ML350 2013-2014
BENZ E350/ML350 2013-2014
- 型号/Model:KPRS-6SE16
- OE:/
- 皮带轮/Pulley:PV6/115
- 电压/Voltage:12V
- 排量/Displacement:160cc

产品介绍

Product Introduction



在乎舒适、可靠、节能，就用康普瑞 & 康普瑞森压缩机

宝马系列

选用型号

BMW SERIES SELECTION MODEL



KPR-96118

- 适用车型/Applications: 宝马3系318 92-99
BMW 3SERIES(E36) 318I
- OE:64528385714/64528390228/
64529069546/8385714/
8390228/9069546
- 皮带轮/Pulley: PV4/115
- 电压/Voltage: 12V



KPR-9652

- 适用车型/Applications: 宝马3系 (E36) 320I
BMW 3SERIES(E36) 320I
- OE:64528385715/64528391474/
64528395474/64529069547/
8385715/8391474/8395474/9069547
- 皮带轮/Pulley: PV5/110
- 电压/Voltage: 12V



KPRS717050008

- 适用车型/Applicable Vehicle: 宝马09-13款M3/07-10款宝马5系525/530
09-13 BMW M3/ 07-10 BMW 525/530
- 编号/Code:KPRS-7SE17
- OE:64526956715
- 皮带轮/Pulley:PV6/110
- 电压/Voltage:12V
- 排量/Displacement:170.5cc



KPRS613056056

- 适用车型/Applicable Vehicle: 宝马F44 1系/F40 116D/新款宝马 迷你
3系双控
BMW 1 F40/F40/116D /BMW 3 MINI
- 编号/Code:KPRS-6SE13
- OE:7948797
- 皮带轮/Pulley:PV6/110
- 电压/Voltage:12V
- 排量/Displacement:133cc



KPRS613057036

- 适用车型/Applicable Vehicle: 新款宝马 迷你3系单控F45
BMW F30
- 编号/Code:KPRS-6SE13
- OE:64529299329
- 皮带轮/Pulley:PV6/110
- 电压/Voltage:12V
- 排量/Displacement:133cc



KPRS717052052

- 适用车型/Applicable Vehicle: 宝马 19款X6/BMW X6 2019
- 编号/Code:KPRS-7SE17
- OE:7948806-02
- 皮带轮/Pulley:PV8/110
- 电压/Voltage:12V
- 排量/Displacement:170.5cc



KPRS717077056

- 适用车型/Applicable Vehicle: 宝马 5系/X5 3.0T
SERIES 5/X5/X7 3.0T
- 编号/Code:KPRS-7SE17
- OE:447140-8311
- 皮带轮/Pulley:PV6/110
- 电压/Voltage:12V
- 排量/Displacement:170.5cc



KPRS613029012

- 适用车型/Applicable Vehicle: 宝马1系 (进口) 2012款 116i
BMW 1 2012 116i
- 型号/Model:KPRS-6SE13
- OE:64529223694
- 皮带轮/Pulley:PV6/110
- 电压/Voltage:12V
- 排量/Displacement:133CC



KPRS717058008

- 适用车型/Applicable Vehicle: 宝马128i/BMW 3-SERIES E90
BMW 128i/BMW 3-SERIES E90
- 型号/Model:KPRS-7SE17
- OE:64529122618
- 皮带轮/Pulley:PV6/110
- 电压/Voltage:12V
- 排量/Displacement:170.5CC



KPRS512001002

- 适用车型/Applicable Vehicle: 宝马3系 E90/BMW 3 E90
- 型号/Model: KPRS-5SL12
- OE: /
- 皮带轮/Pulley: PV6/110
- 电压/Voltage: 12V
- 排量/Displacement: 123cc



KPRS613018036

- 适用车型/Applicable Vehicle: 宝马3系 F30 316i
- 型号/Model: KPRS-6SE13
- OE: 64529222308
- 皮带轮/Pulley: PV6/110
- 电压/Voltage: 12V
- 排量/Displacement: 133cc



KPRS717004008

- 适用车型/Applicable Vehicle: BMW 730/745/760 华晨宝马 3系E66 BMW 730/745/760 BMW Brilliance 3 E66
- 型号/Model: KPRS-7SE17
- OE: 64529122618
- 皮带轮/Pulley: PV6/110
- 电压/Voltage: 12V
- 排量/Displacement: 170.5cc



KPRS717017009

- 适用车型/Applicable Vehicle: BMW 7系E65/E66 BMW 7 E65/E66
- 型号/Model: KPRS-7SE17
- OE: 64526925721
- 皮带轮/Pulley: PV4/110
- 电压/Voltage: 12V
- 排量/Displacement: 170.5cc



KPRS717018023

- 适用车型/Applicable Vehicle: 宝马F18/BMW 7-SERIES F01/F04 730i BMW 5 TOURING 523i/528i/530i BMW F18 BMW 7-Series F01/F04 730i BMW 5 Touring 523i/528i/530i
- 型号/Model: KPRS-7SE17
- OE: 64509196890
- 皮带轮/Pulley: PV8/110
- 电压/Voltage: 12V
- 排量/Displacement: 170.5cc



KPRS717020024

- 适用车型/Applicable Vehicle: 华晨宝马 3系E66 BMW X1 E84
- 型号/Model: KPRS-7SE17
- OE: 64509180549
- 皮带轮/Pulley: PV6/110
- 电压/Voltage: 12V
- 排量/Displacement: 170.5cc



KPRS717004010

- 适用车型/Applicable Vehicle: BMW 5系E60/E61 BMW 7系E65/E66 BMW 5 E60/E61 BMW 7 E65/E66
- 型号/Model: KPRS-7SE17
- OE: 64526917859
- 皮带轮/Pulley: PV4/100
- 电压/Voltage: 12V
- 排量/Displacement: 170.5cc



KPRS717004011

- 适用车型/Applicable Vehicle: BMW 3系E91/E92 BMW Z4 ROADSTER BMW 3 E91/E92 BMW Z4 Roadster
- 型号/Model: KPRS-7SE17
- OE: 64526956719
- 皮带轮/Pulley: PV7/110
- 电压/Voltage: 12V
- 排量/Displacement: 170.5cc



KPRS717005012

- 适用车型/Applicable Vehicle: 宝马X1/X3/BMW X1/X3
- 型号/Model: KPRS-7SE17
- OE: 64529216466
- 皮带轮/Pulley: PV6/110
- 电压/Voltage: 12V
- 排量/Displacement: 170.5cc



KPRS717026009

- 适用车型/Applicable Vehicle: 宝马760单控 BMW 760 Single control
- 型号/Model: KPRS-7SE17
- OE: 64509154072
- 皮带轮/Pulley: PV4/110
- 电压/Voltage: 12V
- 排量/Displacement: 170.5cc



KPRS717027033

- 适用车型/Applicable Vehicle: 宝马760/BMW 760
- 型号/Model: KPRS-7SE17
- OE: 64529154072
- 皮带轮/Pulley: PV7/110
- 电压/Voltage: 12V
- 排量/Displacement: 170.5cc



KPRS717031036

- 适用车型/Applicable Vehicle: 宝马X1/X3/BMW X1/X3
- 型号/Model: KPRS-7SE17
- OE: 64506805025
- 皮带轮/Pulley: PV6/110
- 电压/Voltage: 12V
- 排量/Displacement: 170.5cc



KPRS717006013

- 适用车型/Applicable Vehicle: 宝马GT/宝马X6 BMW GT/BMW X6
- 型号/Model: KPRS-7SE17
- OE: 64529154070
- 皮带轮/Pulley: PV8/110
- 电压/Voltage: 12V
- 排量/Displacement: 170.5cc



KPRS717007014

- 适用车型/Applicable Vehicle: 宝马X4/BMW X4
- 型号/Model: KPRS-7SE17
- OE: 64529217869
- 皮带轮/Pulley: PV8/110
- 电压/Voltage: 12V
- 排量/Displacement: 170.5cc



KPRS717017008

- 适用车型/Applicable Vehicle: 华晨宝马523i/BMW Brilliance 523i
- 型号/Model: KPRS-7SE17
- OE: 64526918753
- 皮带轮/Pulley: PV6/110
- 电压/Voltage: 12V
- 排量/Displacement: 170.5cc



KPRS717049049

- 适用车型/Applicable Vehicle: 宝马07-11款X3 3.0L 8PK(F18单控) BMW 07-11 X3 3.0L 8PK (F18 Single control)
- 型号/Model: KPRS-7SE17
- OE: 64526918749
- 皮带轮/Pulley: PV8/110
- 电压/Voltage: 12V
- 排量/Displacement: 170.5cc



在乎舒适、可靠、节能，就用康普瑞 & 康普瑞森压缩机

华晨系列

选用型号
BRILLIANCE SERIES SELECTION MODEL



KPR-8313

- 适用车型/Applications: 中华V5/H530(替代066-AN9) SAIPA BRILLIANCE
- OE: ATC-066-AN9
- 皮带轮/Pulley: PV5/110
- 电压/Voltage: 12V



KPR-83127

- 适用车型/Applications: 鑫源S22 BRILLIANCE S22
- OE: /
- 皮带轮/Pulley: PV4/110
- 电压/Voltage: 12V



KPR-96143

- 适用车型/Applications: 18款金杯小海狮X30L/T52 1.6L BRILLIANCE JINBEI XIAOHAI SHI X30L/T52 1.6L 2018
- OE: /
- 皮带轮/Pulley: PV5/110
- 电压/Voltage: 12V



KPR-9619

- 适用车型/Applications: 金杯小海狮X30/T30/T52 BRILLIANCE JINBEI XIAOHAI SHI X30/T30/T52
- OE: /
- 皮带轮/Pulley: PV4/110
- 电压/Voltage: 12V



KPR-8323

- 适用车型/Applications: 华晨金杯X30 BRILLIANCE X30
- OE: /
- 皮带轮/Pulley: PV4/110
- 电压/Voltage: 12V

产品介绍

Product Introduction



别克雪佛兰系列

选用型号

BUICK&CHEVROLET SERIES SELECTION MODEL



在乎舒适、可靠、节能，就用康普瑞 & 康普瑞森压缩机



KPR-63109

- 适用车型/Applications: 雪佛兰 SPARK 2012-2015 CHEVROLET SPARK 2012-2015
- OE: 9513641/95194691/95947828/AKT011H203/AKT200A201/AKT200A202/95136417/AKT200A203
- 皮带轮/Pulley: PV4/95
- 电压/Voltage: 12V



KPR-96117

- 适用车型/Applications: 雪佛兰爱唯欧 CHEVROLET AVEO 12' CHEVROLET CRUZE
- OE: 96863368/13376447/96966630/13271258/13250601/13310692/119250587/108190574
- 皮带轮/Pulley: PV6/110
- 电压/Voltage: 12V



KPR-96194

- 适用车型/Applications: 雪佛兰欧宝 MOKKA 1.6 2017款 OPEL MOKKA 1.6 2017/MOKKA / MOKKA X : 1.6 CDTI 06.2015-/MOKKA / MOKKA X : 1.6 CDTI 4x4 01.2015 -
- OE: 424569346934/94559597/AKT200A427G/0013560/AKT011H403AS
- 皮带轮/Pulley: PV6/95
- 电压/Voltage: 12V



KPR-1115

- 适用车型/Applications: 雪佛兰库罗德 CHEVROLET COLARADO 2012
- OE: 52061675
- 皮带轮/Pulley: PV6/133
- 电压/Voltage: 12V



KPR-1258

- 适用车型/Applications: 雪佛兰S10 GM S10 12-17'/CHEVROLET S10 FLEX 2013/GRAND BLAZER 2013 2014 2.4
- OE: 52063997/93541634/597910629/90032967/52045970
- 皮带轮/Pulley: PV6/134
- 电压/Voltage: 12V



KPR-1292

- 适用车型/Applications: 雪佛兰 LUX D-MAX CHEVROLET LUX D-MAX
- OE: 8973694180/2407460001P
- 皮带轮/Pulley: PV6/125
- 电压/Voltage: 12V



KPR-1117

- 适用车型/Applications: 雪佛兰 CHEVROLET
- OE: /
- 皮带轮/Pulley: PV6/115.8
- 电压/Voltage: 12V



KPR-83116

- 适用车型/Applications: 雪佛兰爱唯欧 CHEVROLET AVEO
- OE: /
- 皮带轮/Pulley: PV5/96.5
- 电压/Voltage: 12V



KPR-8314

- 适用车型/Applications: 雪佛兰20款创酷 CHEVROLET TRACKER 2020
- OE: /
- 皮带轮/Pulley: PV4/94.5
- 电压/Voltage: 12V



KPR-6384

- 适用车型/Applications: 雪佛兰12款SPARK CHEVROLET SPARK 2012-2015
- OE: 9513641/AKT200A203
- 皮带轮/Pulley: PV4/95
- 电压/Voltage: 12V



KPR-83148

- 适用车型/Applicable Vehicle: 雪佛兰 20款科鲁泽混动1.0T Chevrolet Cruze Hybrid 1.0T 2020
- OE: /
- 皮带轮/Pulley: PV7/95
- 电压/Voltage: 12V



KPR-8321

- 适用车型/Applications: 爱唯欧6PK海外版 CHEVROLET AVEO 1.4I 2013- <6PK>/CHEVROLET SONIC 1.4I 2013- <6PK>
- OE: 95059818/AKT011H403G/AKT200A408/AKT200A415/AKT200A4408A/1618509/1618548/95370313
- 皮带轮/Pulley: PV6/95
- 电压/Voltage: 12V



KPR-8324

- 适用车型/Applications: 雪佛兰 SONIC CHEVROLET SONIC
- OE: 52067902/95370313/95370317/95059819/GR911701/AKT200A415/AKT200A408/AKT011H403F/5561122788
- 皮带轮/Pulley: PV5/96.5
- 电压/Voltage: 12V



KPR-8333

- 适用车型/Applications: 18款英朗/科沃兹1.0T EXCELLE GT /KOWOZ 1.0T 2018
- OE: 26220451/E174241175D
- 皮带轮/Pulley: PV5/95
- 电压/Voltage: 12V



KPR-8338

- 适用车型/Applications: 别克昂科拉 BUICK ENCORE 2014/BUICK OPEL/CHEVROLETSONIC/TRAX MOKKA
- OE: AKT200A413/AKT011H403T/95369542/AKT200A409/700510946/ACP01045/AKT011H403H
- 皮带轮/Pulley: PV6/95
- 电压/Voltage: 12V



KPR-8346

- 适用车型/Applications: 雪佛兰科鲁泽 1.3T CHEVROLET MONZA 1.3T
- OE: /
- 皮带轮/Pulley: PV7/95
- 电压/Voltage: 12V



KPR-8349

- 适用车型/Applications: 2020款昂科拉/创酷 CHEVROLET TRACKER 2019 BUICK ENCORE 2019
- OE: 26699506/64304-8349
- 皮带轮/Pulley: PV5/100
- 电压/Voltage: 12V



KPR-8361

- 适用车型/Applications: 别克昂科拉2014款 BUICK ENCORE 2014
- OE: /
- 皮带轮/Pulley: PV5/96.5
- 电压/Voltage: 12V



KPR-8349P

- 适用车型/Applications: 20款 昂科拉 4PK ENCORE 2020 4PK
- OE: /
- 皮带轮/Pulley: PV4/94
- 电压/Voltage: 12V



KPRS616007006

- 适用车型/Applicable Vehicle: 迈锐宝XL1.5T/16款新君越1.5 MalibuXL 1.5T/Lacrosse 2016
- 编号/Code: KPRS-PXC16
- OE: /
- 皮带轮/Pulley: PV5/110
- 电压/Voltage: 12V
- 排量/Displacement: 160cc



KPRS616008007

- 适用车型/Applicable Vehicle: 迈锐宝 2.0T/新君越2.4/2012君威2.0/2.4 Malibu2.0T/New Lacrosse 2.4/Regal 2.0/2.4 2012
- 编号/Code: KPRS-PXC16
- OE: 22947669
- 皮带轮/Pulley: PV6/120
- 电压/Voltage: 12V
- 排量/Displacement: 160cc



KPRS616008008

- 适用车型/Applicable Vehicle: 迈锐宝1.5T/2012款君威/2012款君越 Malibu1.5T/Regal 2012 Lacrosse 2012
- 编号/Code: KPRS-PXC16
- OE: 22861238
- 皮带轮/Pulley: PV5/120
- 电压/Voltage: 12V
- 排量/Displacement: 160cc



KPRS616015015

- 适用车型/Applicable Vehicle: 2009-2011款君威、君越2.0、2.4 Regal, Lacrosse2.0、2.4 2009-2011
- 编号/Code: KPRS-PXE16
- OE: 13232305
- 皮带轮/Pulley: PV6/120
- 电压/Voltage: 12V
- 排量/Displacement: 160cc



KPRS616022022

- 适用车型/Applicable Vehicle: 别克昂科威1.5T BUICK ENVISION 1.5T
- 编号/Code: KPRS-VS16
- OE: /
- 皮带轮/Pulley: PV5/110
- 电压/Voltage: 12V
- 排量/Displacement: 160cc



KPRS616022023

- 适用车型/Applicable Vehicle: 别克昂科威2.0 BUICK ENVISION 2.0T
- 编号/Code: KPRS-VS16
- OE: /
- 皮带轮/Pulley: PV5/110
- 电压/Voltage: 12V
- 排量/Displacement: 160cc



KPRS717035035

- 适用车型/Applicable Vehicle: 2016-2017款凯迪拉克CT6 2.0T Cadillac CT6 2.0T 2016-2017
- 型号/Model: KPRS-TSE17
- OE: 23287035
- 皮带轮/Pulley: PV5/110
- 电压/Voltage: 12V
- 排量/Displacement: 170.5cc



KPRS616006009

- 适用车型/Applicable Vehicle: 2019款迈锐宝1.3T/2016款君越2.0T 4PK Malibu 1.3T 2019/Lacrosse 2.0T 2016
- 编号/Code: KPRS-PXC16
- OE: /
- 皮带轮/Pulley: PV4/110
- 电压/Voltage: 12V
- 排量/Displacement: 160cc



KPRS613012006

- 适用车型/Applicable Vehicle: 别克威朗/科鲁兹旗舰1.5/GL6双控 Buick VERANO/Cruze flagship 1.5/GL6
- 编号/Code: KPRS-PXC14
- OE: 13427936
- 皮带轮/Pulley: PV5/110
- 电压/Voltage: 12V
- 排量/Displacement: 133cc



KPRS613017017

- 适用车型/Applicable Vehicle: GL6 /沃兰多 GL6/Orlando
- 编号/Code: KPRS-PXE14
- OE: 101621141
- 皮带轮/Pulley: PV5/110
- 电压/Voltage: 12V
- 排量/Displacement: 133cc



KPRS616006006

- 适用车型/Applicable Vehicle: 迈锐宝XL/XT5/2016款君越2.0T 别克GL8 2.5 (18-19) Malibu XL/XT5/LaCrosse 2.0T 2016/Buick GL8 2.5 (18-19)
- 编号/Code: KPRS-PXC16
- OE: 84390550
- 皮带轮/Pulley: PV5/110
- 电压/Voltage: 12V
- 排量/Displacement: 160cc



KPRS616043044

- 适用车型/Applicable Vehicle: 别克22款GL8 Buick GL8 2022
- 型号/Model: KPRS-PXC16
- OE:
- 皮带轮/Pulley: PV7/120
- 电压/Voltage: 12V
- 排量/Displacement: 160cc



KPRS616043043

- 适用车型/Applicable Vehicle: 别克、21款GL8混动 凯迪拉克、21款XT6 21 GL8 2.0T/21 Cadillac XT5
- 编号/Code: KPRS-PXC16
- OE: 84809866
- 皮带轮/Pulley: PV7/110
- 电压/Voltage: 12V
- 排量/Displacement: 160cc



KPRS613053052

- 适用车型/Applicable Vehicle: 凯迪拉克20款CT5 2.0T Cadillac CT5 2.0 2020
- 编号/Code: KPRS-PXC14
- OE: /
- 皮带轮/Pulley: PV5/110
- 电压/Voltage: 12V
- 排量/Displacement: 133cc



KPRS616052052

- 适用车型/Applicable Vehicle: 20款别克GL8 2.0 凯迪拉克XT4/XT5 2.0 MALIBU 1.5L 2016-2021
- 编号/Code: KPRS-PXC16
- OE: 1522335
- 皮带轮/Pulley: PV5/110
- 电压/Voltage: 12V
- 排量/Displacement: 160cc



KPRS613024024

- 适用车型/Applicable Vehicle: 凯迪拉克ATS Cadillac ATS
- 型号/Model: KPRS-6SE13
- OE: /
- 皮带轮/Pulley: PV5/110
- 电压/Voltage: 12V
- 排量/Displacement: 133cc



KPRS717047035

- 适用车型/Applicable Vehicle: 凯迪拉克19款CT6 2.0T Cadillac CT6 2.0T 2019
- 型号/Model: KPRS-7SE17
- OE: 84493386
- 皮带轮/Pulley: PV5/110
- 电压/Voltage: 12V
- 排量/Displacement: 170.5cc



KPRS613052052

- 适用车型/Applicable Vehicle: 20款昂科威2.0 20 Envision 2.0
- 型号/Model: KPRS-PXC14
- OE:
- 皮带轮/Pulley: PV5/110
- 电压/Voltage: 12V
- 排量/Displacement: 133cc



在乎舒适、可靠、节能，就用康普瑞 & 康普瑞森压缩机

长安系列 选用型号

CHANGAN SERIES SELECTION MODEL



KPR-8380

- 适用车型/Applications: 长安跨越X3/T3/X1
CHANGAN KUAYUE X3/T3/X1
- OE: /
- 皮带轮/Pulley: PV5/100
- 电压/Voltage: 12V



KPR-83119

- 适用车型/Applications: 长安跨越星V3
CHANGAN KUAYUE STAR V3
- OE: /
- 皮带轮/Pulley: PV5/95
- 电压/Voltage: 12V



KPR-8327

- 适用车型/Applications: 长安跨越X1/T3
CHANGAN KUAYUE X1T3
- OE: /
- 皮带轮/Pulley: PV5/95
- 电压/Voltage: 12V



KPR-9601

- 适用车型/Applications: 长安之星
CHANGAN STAR
- OE: /
- 皮带轮/Pulley: 单O槽/110
- 电压/Voltage: 12V



KPR-9603

- 适用车型/Applications: 长安CM5(1.3)
CHANGAN CM5(1.3)
- OE: /
- 皮带轮/Pulley: 单O槽/110
- 电压/Voltage: 12V



KPR-9610

- 适用车型/Applications: 长安CM5
CHANGAN CM5
- OE: /
- 皮带轮/Pulley: 单O槽/110
- 电压/Voltage: 12V



KPR-9613

- 适用车型/Applications: 长安4500新款
CHANGAN SC4500 NEW SERIES
- OE: /
- 皮带轮/Pulley: 单O槽/110
- 电压/Voltage: 12V



KPR-9617

- 适用车型/Applications: 长安金牛星
CHANGAN GOLDEN BULL
- OE: AKC200A204P
- 皮带轮/Pulley: PV4/110
- 电压/Voltage: 12V



KPR-9624

- 适用车型/Applications: 长安奔奔1.0L
CHANGAN BENBEN 1.0L
- OE: /
- 皮带轮/Pulley: 单O槽/Φ118
- 电压/Voltage: 12V



KPR-9625

- 适用车型/Applications: 长安奔奔1.3L CHANGAN BENBEN 1.3L
- OE: /
- 皮带轮/Pulley: PV4/110
- 电压/Voltage: 12V



KPR-9627

- 适用车型/Applications: 长安悦翔4PK/12款悦翔 (4PK)/CX30 1.6 CHANGAN YUEXIANG 2012 (4PK)/CX30 1.6
- OE: /
- 皮带轮/Pulley: PV4/110
- 电压/Voltage: 12V



KPR-7205

- 适用车型/Applications: 长安凯程星卡 CHANGAN KAICHENG STAR TRUCK
- OE: /
- 皮带轮/Pulley: PV4/95
- 电压/Voltage: 12V



KPR-9689

- 适用车型/Applications: 长安跨越X5 CHANGAN KUAYUE X5
- OE: /
- 皮带轮/Pulley: A1/114.6
- 电压/Voltage: 12V



KPR-9693

- 适用车型/Applications: 长安新悦翔 V3 CHANGAN NEW YUEXIANG V3
- OE: /
- 皮带轮/Pulley: PV4/110
- 电压/Voltage: 12V



KPR-96115

- 适用车型/Applications: 跨越D5 CHANGAN KUAYUE D5
- OE: /
- 皮带轮/Pulley: PV6/110
- 电压/Voltage: 12V



KPR-9640

- 适用车型/Applications: 新长安之星 CHANGAN NEW STAR
- OE: /
- 皮带轮/Pulley: PV4/100
- 电压/Voltage: 12V



KPR-9646

- 适用车型/Applications: 长安之星7 CHANGAN STAR 7
- OE: /
- 皮带轮/Pulley: PV4/110
- 电压/Voltage: 12V



KPR-9653

- 适用车型/Applications: 长安欧诺1.3L/欧诺12款 (替代086-AQ3) CHANGAN OUNO 1.3L & 2012 ED
- OE: /
- 皮带轮/Pulley: PV4/100
- 电压/Voltage: 12V



KPR-96126

- 适用车型/Applications: 长安跨越D5 柴油 CHANGAN KUAYUE D5 DIESEL
- OE: /
- 皮带轮/Pulley: PV6/120
- 电压/Voltage: 24V



KPR-96135

- 适用车型/Applications: 长安跨越星V5 CHANGAN KUAYUEXING V5
- OE: /
- 皮带轮/Pulley: PV5/95
- 电压/Voltage: 12V



KPR-96139

- 适用车型/Applications: 长安跨越D5/东安1.6 CHANGAN KUAYUE D5/ DONGAN 1.6
- OE: /
- 皮带轮/Pulley: PV5/φ106
- 电压/Voltage: 12V



KPR-9654

- 适用车型/Applications: 长安欧诺1.5L (替代086-AQ10) CHANGAN OUNO 1.5L
- OE: /
- 皮带轮/Pulley: PV5/100
- 电压/Voltage: 12V



KPR-9655

- 适用车型/Applications: 长安之星9 CHANGAN STAR 9
- OE: /
- 皮带轮/Pulley: PV5/110
- 电压/Voltage: 12V



KPR-9677

- 适用车型/Applications: 长安跨越 CHANGAN KUAYUE
- OE: /
- 皮带轮/Pulley: PV4/100
- 电压/Voltage: 12V



KPR-96141

- 适用车型/Applications: 跨越D5 KUAYUE D5
- OE: /
- 皮带轮/Pulley: PV6/110
- 电压/Voltage: 12V



KPR-96146

- 适用车型/Applications: 长安跨越星V5 CHANGAN KUAYUEXING V5
- OE: /
- 皮带轮/Pulley: PV4/95
- 电压/Voltage: 12V



KPR-1110

- 适用车型/Applications: 长安CS15 CHANGAN CS15
- OE: /
- 皮带轮/Pulley: PV4/107
- 电压/Voltage: 12V



KPR-1225

- 适用车型/Applications: 长安逸动/CS35/12款悦翔 CHANGAN EADO/CS35/2012 YUEXIANG
- OE: /
- 皮带轮/Pulley: PV6/118
- 电压/Voltage: 12V



KPR-1235

- 适用车型/Applications: 长安欧尚 CHANGAN OUSHAN
- OE: /
- 皮带轮/Pulley: PV4/Φ110
- 电压/Voltage: 12V



KPR-1250

- 适用车型/Applications: 长安睿行M80 CHANGAN STAR TRUCK M80
- OE: /
- 皮带轮/Pulley: PV5/110
- 电压/Voltage: 12V



KPR-1251

- 适用车型/Applications: 长安欧尚X5/CS55 1.5T COSMOS X5/CS55 1.5T
- OE: A1030A1/JSR12T608004
- 皮带轮/Pulley: PV6/110
- 电压/Voltage: 12V



KPR-1257

- 适用车型/Applications: 长安CX70 CHANGAN CX70
- OE: /
- 皮带轮/Pulley: PV6/110
- 电压/Voltage: 12V



KPR-1276

- 适用车型/Applications: 长安CS35 PLUS CHANGAN CS35 PLUS
- OE: /
- 皮带轮/Pulley: PV6/118
- 电压/Voltage: 12V



KPR-9602

- 适用车型/Applications: 长安CM5(1.0L)/CM9(1.0L) CHANGAN CM5(1.0L)/CM9(1.0L)
- OE: 95200-70C20/95201-70C20 95201-77G01/811101010
- 皮带轮/Pulley: 单O槽/118
- 电压/Voltage: 12V



KPR-8366

- 适用车型/Applications: 长安跨越星V4 CHANGAN KUAYUE STAR V4
- OE: /
- 皮带轮/Pulley: PV4/95
- 电压/Voltage: 12V



KPR-1126

- 适用车型/Applications: 跨越皮卡 CHANA KUAYUE PICKUP
- OE: /
- 皮带轮/Pulley: PV5/106
- 电压/Voltage: 12V



KPR-12109

- 适用车型/Applications: 长安睿行 M90 CHANGAN STAR TRUCK M90
- OE: /
- 皮带轮/Pulley: PV6/110
- 电压/Voltage: 12V



KPR-9606

- 适用车型/Applications: 长安465双槽 CHANGAN 465 DOUBLE SLOT
- OE: /
- 皮带轮/Pulley: PV4/110
- 电压/Voltage: 12V



KPR-9612

- 适用车型/Applications: 哈飞赛马 HAFEI SAIMA
- OE: /
- 皮带轮/Pulley: PV5/110
- 电压/Voltage: 12V



KPR-96181

- 适用车型/Applications: DK12 (24V) CHANGAN DK12 (24V)
- OE: /
- 皮带轮/Pulley: PV4/100
- 电压/Voltage: 24V



KPR-9637

- 适用车型/Applications: 长安CC CHANGAN KUAYUE CC
- OE: /
- 皮带轮/Pulley: PV6/118
- 电压/Voltage: 12V



KPR-9636

- 适用车型/Applications: 长安CX30 1.6/陆风风华 CHANGAN CX30 1.6 / LUFENG FENGHUA
- OE: /
- 皮带轮/Pulley: PV4/110
- 电压/Voltage: 12V



KPR-96180

- 适用车型/Applications: 长安跨越X5 CHANGAN KUAYUE X5
- OE: /
- 皮带轮/Pulley: PV6/120
- 电压/Voltage: 12V



KPR-96172

- 适用车型/Applications: 跨越D5 长城1.5T 发动机 KUAYUE D5 (POWERED BY GREAT WALL 1.5T)
- OE: /
- 皮带轮/Pulley: PV5/100
- 电压/Voltage: 12V



KPRS616028028

- 适用车型/Applicable Vehicle: 长安CS95 CHANGAN CS95
- 编号/Code: KPRS-6SE16
- OE: S401021-0101
- 皮带轮/Pulley: PV6/110
- 电压/Voltage: 12V
- 排量/Displacement: 160cc



KPRS716501501

- **适用车型/Applicable Vehicle:**
长安CS55/1.5/17款欧尚A800
CHANGAN CS55/1.5/
OSHAN A800 2017
- **编号/Code:**KPRS-7V16
- **OE:**B511F280103-0700
- **皮带轮/Pulley:**PV6/110
- **电压/Voltage:**12V
- **排量/Displacement:**160.5cc



KPRS716504504

- **适用车型/Applicable Vehicle:**
长安CS75 1.8T
CHANGAN CS75 1.8T
- **编号/Code:**KPRS-7V16
- **OE:**K012-1300-AA
- **皮带轮/Pulley:**PV6/110
- **电压/Voltage:**12V
- **排量/Displacement:**160.5cc



KPRS614004004

- **适用车型/Applicable Vehicle:**
长安18款逸动四脚
CHANGAN EADO 2018
- **编号/Code:**KPRS-VS14
- **OE:**NE14T004-0380
- **皮带轮/Pulley:**PV6/110
- **电压/Voltage:**12V
- **排量/Displacement:**133cc

产品介绍

Product Introduction



在乎舒适、可靠、节能，就用康普瑞 & 康普瑞森压缩机

东风系列 选用型号

DONGFENG SERIES SELECTION MODEL



KPR-9623

- 适用车型/Applications: 东风多利卡 DONGFENG DUOLIKA
- OE: /
- 皮带轮/Pulley: PV8/119
- 电压/Voltage: 24V



KPR-9630

- 适用车型/Applications: 东风小康C37 DONGFENG XIAOKANG C37
- OE: /
- 皮带轮/Pulley: PV4/Φ100
- 电压/Voltage: 12V



KPR-1274

- 适用车型/Applications: 东风风行景逸1.5/1.8 (替代106-15) DONGFENG FENGXING JINGYI 1.5/1.8L (SUPERSEDES 106-15)
- OE: /
- 皮带轮/Pulley: PV5/110
- 电压/Voltage: 12V



KPR-9663

- 适用车型/Applications: 东风风光330/370 DONGFENG FENGGUANG 330/370
- OE: /
- 皮带轮/Pulley: PV4/Φ100
- 电压/Voltage: 12V



KPR-12107D

- 适用车型/Applications: 风行22款菱智 PLUS (替代106-17) DONGFENG FENGXING LINGZHI PLUS 2022
- OE: /
- 皮带轮/Pulley: PV6/Φ100
- 电压/Voltage: 12V



KPR-9690

- 适用车型/Applications: 东风风光S560/IX5 DONGFENG FENGGUANG S560/IX5
- OE: /
- 皮带轮/Pulley: PV6/105
- 电压/Voltage: 12V



KPR-1408

- 适用车型/Applications: 东风皮卡 DONGFENG RICH PICKUP
- OE: /
- 皮带轮/Pulley: A2/132
- 电压/Voltage: 24V



KPR-1415

- 适用车型/Applications: 东风轻卡金霸 DONGFENG JINBA LIGHT TRUCK
- OE: /
- 皮带轮/Pulley: A2/132
- 电压/Voltage: 12V



KPR-1273

- 适用车型/Applications: 东风风行菱智1.5/1.6 (替代106-14) DONGFENG FENGXING LINGZHI 1.5/1.6 (SUPERSEDES 106-14)
- OE: /
- 皮带轮/Pulley: PV5/110
- 电压/Voltage: 12V



KPR-1229

- 适用车型/Applications: 东风风光580 1.5T FENCON 580 1.5T
- OE: /
- 皮带轮/Pulley: PV4/110
- 电压/Voltage: 12V



KPR-1237

- 适用车型/Applications: 东风风光580 1.5T国VI FENCON 580 1.5T (VI)
- OE: /
- 皮带轮/Pulley: PV6/110
- 电压/Voltage: 12V



KPR-9605

- 适用车型/Applications: 东风小康V27 DONGFENG XIAOKANG V27
- OE: /
- 皮带轮/Pulley: 单O槽/110
- 电压/Voltage: 12V



KPR-1272

- 适用车型/Applications: 17款东风风行菱智M3(替代106-ZZ1) DONGFENG FENGXING LINGZHI M3 2017 (SUPERSEDES 106-ZZ1)
- OE: /
- 皮带轮/Pulley: PV6/110
- 电压/Voltage: 12V

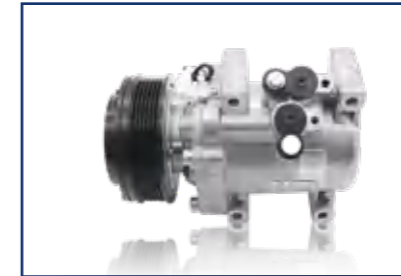

KPR-1238

- 适用车型/Applications: 东风风光580 1.8L DONGFENG FENGGUANG 580 1.8L
- OE: /
- 皮带轮/Pulley: PV6/110
- 电压/Voltage: 12V



KPR-96125

- 适用车型/Applications: 东风多利卡 R12接口/吉奥皮卡/小吉奥12V DONGFENG DUOLIKA R12IN TERFACE/GIO PICA/LITTLE GIO 12V
- OE: /
- 皮带轮/Pulley: A1/124
- 电压/Voltage: 12V



KPR-96100

- 适用车型/Applications: 唐骏欧铃/时风风云Q DONGFENG FENGGUANG N1 MPV (COMMERCIAL CONFIG)
- OE: /
- 皮带轮/Pulley: PV6/110
- 电压/Voltage: 12V



KPR-96104

- 适用车型/Applications: 东风风行景逸X5 (替代086-BR11) DONGFENG FENGXING JINGYI X5 (SUPERSEDES 086-BR11)
- OE: /
- 皮带轮/Pulley: PV5/100
- 电压/Voltage: 12V



KPR-96105

- 适用车型/Applications: 景逸X5、海马 (可替代086-BR1) DONGFENG FENGXING JINGYI X5/HAIMA(SUPERSEDES 086-BR1)
- OE: /
- 皮带轮/Pulley: PV5/110
- 电压/Voltage: 12V



KPR-96124

- 适用车型/Applications: 东风多利卡 R12接口/吉奥皮卡 DONGFENG DOLIKA R12 INTERFACE & GA PICKUP SYSTEM
- OE: /
- 皮带轮/Pulley: A1/124
- 电压/Voltage: 24V



KPR-96154

- 适用车型/Applications: 东风凯马轻卡1.5 DONGFENG KAMA 1.5T LIGHT TRUCK
- OE: /
- 皮带轮/Pulley: PV5/116
- 电压/Voltage: 12V



KPR-96162

- 适用车型/Applications: 东风小康C71/C72/风光500 1.5T DONGFENG XIAOKANG C71/C72 / FENGGUANG 500 1.5T
- OE: /
- 皮带轮/Pulley: PV4/105
- 电压/Voltage: 12V

产品介绍

Product Introduction



在乎舒适、可靠、节能，就用康普瑞 & 康普瑞森压缩机

工程车、卡车系列 选用型号

ENGINEERING VEHICLE、TRUCK SERIES
SELECTION MODEL



KPR-6356

- 适用车型/Applications:
久保田单O
DAIHATSU HIJET S200P/SIN
GLE O-GROOVE
- OE: 88310-B5020/447190-2214/88320-975
07/447260-5800/447260-506/88410-97505/2
47300-3901
- 皮带轮/Pulley: 单O槽/118
- 定线尺寸/Gauge line: 48.5
- 电压/Voltage: 12V



KPR-1293

- 适用车型/Applications:
小松挖机
KOMATSU HYDRAULIC
EXCAVATOR
- OE: /
- 皮带轮/Pulley: B1/135
- 定线尺寸/Gauge line: 54.3
- 电压/Voltage: 24V



KPR-7202

- 适用车型/Applications:
中联小挖
ZOOMLION SMALL EXCAVATOR
- OE: /
- 皮带轮/Pulley: 单O槽/110
- 定线尺寸/Gauge line: 48.5
- 电压/Voltage: 12V



KPR-7204

- 适用车型/Applications:
中联小挖
ZOOMLION SMALL EXCAVATOR
- OE: /
- 皮带轮/Pulley: A1/115
- 定线尺寸/Gauge line: 57.2
- 电压/Voltage: 12V



KPR-83120

- 适用车型/Applications:
大发 TANTO
DAIHATSU MOVE HIJET LA700V
LA710V
- OE: 447140-1610/88320-B2100/
88320-B2140
- 皮带轮/Pulley: PV3/110
- 定线尺寸/Gauge line: 88.3
- 电压/Voltage: 12V



KPR-8383

- 适用车型/Applications:
久保田单O槽
KUBOTA TRACTOR/SINGLE
O-GROOVE
- OE: 6251414M91/6251414M92/624453
6M92/6A671-97110/6A671-97114
- 皮带轮/Pulley: 单O槽/118
- 定线尺寸/Gauge line: 82.2
- 电压/Voltage: 12V



KPR-9608

- 适用车型/Applications:
厢式冷藏车
REFRIGERATOR CAR
- OE: /
- 皮带轮/Pulley: A1/114
- 定线尺寸/Gauge line: 39.5
- 电压/Voltage: 24V



KPR-1246

- 适用车型/Applications:
玉柴挖机
YUCHAI EXCAVATOR
- OE: /
- 皮带轮/Pulley: A1/140
- 定线尺寸/Gauge line: 81.2
- 电压/Voltage: 24V



KPR-9618

- 适用车型/Applications:
工程车
ENGINEERING VEHICLES
- OE: /
- 皮带轮/Pulley: A1/114
- 定线尺寸/Gauge line: 39.5
- 电压/Voltage: 24V



KPR-6327

- 适用车型/Applications: 久保田长脚12V KUBOTA EXCAVATOR 12V
- OE: 447180-5090/447260-5570/447180-6430/447190-2742/447220-6750/447260-5540/447220-6771/3C581-97590/88310-B2140
- 皮带轮/Pulley: A1/120
- 定线尺寸/Gauge line: 55.5
- 电压/Voltage: 12V



KPR-6328

- 适用车型/Applications: 久保田短脚 12V KUBOTA 203H55
- OE: T2055-7225/DCP99832/447190-4020
- 皮带轮/Pulley: 单O槽/110
- 定线尺寸/Gauge line: 48.5
- 电压/Voltage: 12V



KPR-6339

- 适用车型/Applications: 久保田6PK/DAIHATSU HIJET / MOVE / COPEN 2003(6PK)
- OE: 447280-3080/447280-3050/16003686-101/16003686-102/16003686-103/16003686-104/3P999-00620/3C581-50060/3C581-97590/447220-6771/447220-6750/447260-5780/447260-5781
- 皮带轮/Pulley: 6PK Φ109
- 定线尺寸/Gauge line: 47.8
- 电压/Voltage: 12V



KPR-6343

- 适用车型/Applications: 久保田长脚 KUBOTA
- OE: /
- 皮带轮/Pulley: A1/112
- 定线尺寸/Gauge line: 50
- 电压/Voltage: 12V



KPR-6344

- 适用车型/Applications: 久保田(收割机) KUBOTA(HARVESTER)
- OE: 447180-5090/447220-6771/447220-6750/447260-5540/247300-2320
- 皮带轮/Pulley: A1/112
- 定线尺寸/Gauge line: 50
- 电压/Voltage: 12V



KPR-1248

- 适用车型/Applications: 卡特挖机8PK CAT EXCAVATOR / 8PK
- OE: /
- 皮带轮/Pulley: PV8/140
- 定线尺寸/Gauge line: 73.9
- 电压/Voltage: 24V



KPR-6353

- 适用车型/Applications: 久保田单O槽 KUBOTA/SINGLE O-GROOVE
- OE: /
- 皮带轮/Pulley: 单O槽/123
- 定线尺寸/Gauge line: 52.5
- 电压/Voltage: 12V



KPR-6354

- 适用车型/Applications: 久保田挖机(长脚) DAIHATSU HIJET
- OE: 447260-5480/447200-9465/447200-4608
- 皮带轮/Pulley: A1/120
- 定线尺寸/Gauge line: 55.5
- 电压/Voltage: 12V



KPR-6355

- 适用车型/Applications: 久保田3PK DAIHATSU HIJET 3PK
- OE: 88310B5070
- 皮带轮/Pulley: PV3/125
- 定线尺寸/Gauge line: 48.5
- 电压/Voltage: 12V



KPR-6327A

- 适用车型/Applications: 久保田长脚12V KUBOTA EXCAVATOR 12V
- OE: 447180-5090/447260-5570 447180-6430/447190-2742
- 皮带轮/Pulley: A1/120
- 定线尺寸/Gauge line: 55.5
- 电压/Voltage: 24V



KPR-9675

- 适用车型/Applications: 工程车专用 SPECIAL FOR ENGINEERING VEHICLES
- OE: /
- 皮带轮/Pulley: A1/114
- 定线尺寸/Gauge line: 41.3
- 电压/Voltage: 24V



KPR-9688

- 适用车型/Applications: 工程车-中单A 24V ENGINEERING VEHICLE/MID-SINGLE A-GROOVE 24V
- OE: /
- 皮带轮/Pulley: A1/115
- 定线尺寸/Gauge line: 43
- 电压/Voltage: 24V



KPR-1243

- 适用车型/Applications: 卡特320 CAT 320
- OE: /
- 皮带轮/Pulley: B1/152
- 定线尺寸/Gauge line: 71.1
- 电压/Voltage: 24V



KPR-96145

- 适用车型/Applications: 前单A ENGINEERING MACHINERY
- OE: /
- 皮带轮/Pulley: A1/114.6
- 定线尺寸/Gauge line: 48.5
- 电压/Voltage: 12V



KPR-1244

- 适用车型/Applications: 小松挖机 KOMATSU HYDRAULIC EXCAVATOR
- OE: /
- 皮带轮/Pulley: B1/152
- 定线尺寸/Gauge line: 73.5
- 电压/Voltage: 24V



KPR-9618A

- 适用车型/Applications: 工程车 ENGINEERING VEHICLES
- OE: /
- 皮带轮/Pulley: 单A槽 Φ114
- 定线尺寸/Gauge line: 39.5
- 电压/Voltage: 12V



KPRS715023024

- 适用车型/Applicable Vehicle: 卡特彼勒/Caterpillar
- 编号/Code: KPRS-7H15
- OE: SD4769
- 皮带轮/Pulley: PV8/133
- 定线尺寸/Gauge line: 61.5
- 电压/Voltage: 24V
- 排量/Displacement: 155cc



KPRS715022024

- 适用车型/Applicable Vehicle: 卡特彼勒/Caterpillar
- 编号/Code: KPRS-7H15
- OE: 1419676
- 皮带轮/Pulley: PV8/133
- 定线尺寸/Gauge line: 46.5
- 电压/Voltage: 24V
- 排量/Displacement: 155cc



KPRS715023042

- 适用车型/Applicable Vehicle: 工程机械/Construction Machinery
- 编号/Code: KPRS-7H15
- OE: 1630872
- 皮带轮/Pulley: PV8/153
- 定线尺寸/Gauge line: 65
- 电压/Voltage: 24V
- 排量/Displacement: 155cc



KPRS715036038

- 适用车型/Applicable Vehicle: 通用型/UNIVERSAL VERSION
- 编号/Code: KPRS-7H15
- OE: /
- 皮带轮/Pulley: PV8/119
- 定线尺寸/Gauge line: 46.5
- 电压/Voltage: 24V
- 排量/Displacement: 155cc



KPRS715005006

- 适用车型/Applicable Vehicle: 斯堪尼亚/SCANIA
- 编号/Code: KPRS-7H15
- OE: 2564093
- 皮带轮/Pulley: PV10/120
- 定线尺寸/Gauge line: 63.8
- 电压/Voltage: 24V
- 排量/Displacement: 155cc



KPRS715002007

- 适用车型/Applicable Vehicle: 依维柯/Iveco
- 编号/Code: KPRS-7H15
- OE: 8500795
- 皮带轮/Pulley: PV8/119
- 定线尺寸/Gauge line: 52
- 电压/Voltage: 24V
- 排量/Displacement: 155cc



KPRS715007004

- 适用车型/Applicable Vehicle: 沃尔沃卡车/Volvo
- 编号/Code: KPRS-7H15
- OE: 813065
- 皮带轮/Pulley: PV8/132
- 定线尺寸/Gauge line: 56.5
- 电压/Voltage: 24V
- 排量/Displacement: 155cc



KPRS715017014

- 适用车型/Applicable Vehicle: 工程机械/CONSTRUCTION MACHINERY
- 编号/Code: KPRS-7H15
- OE: 75R84622
- 皮带轮/Pulley: PV8/119
- 定线尺寸/Gauge line: 61.5
- 电压/Voltage: 12V
- 排量/Displacement: 155cc



KPRS715007048

- 适用车型/Applicable Vehicle: 沃尔沃工程车/Volvo NH 1999
- 编号/Code: KPRS-7H15
- OE: 11412631
- 皮带轮/Pulley: PV8/132
- 定线尺寸/Gauge line: 56.5
- 电压/Voltage: 24V
- 排量/Displacement: 155cc



KPRS715010013

- 适用车型/Applicable Vehicle: 工程机械/Construction Machinery
- 编号/Code: KPRS-7H15
- OE: 3962042
- 皮带轮/Pulley: A2/125
- 定线尺寸/Gauge line: 39.5
- 电压/Voltage: 24V
- 排量/Displacement: 155cc



KPRS715022023

- 适用车型/Applicable Vehicle: 卡特彼勒/Caterpillar
- 编号/Code: KPRS-7H15
- OE: 1065122
- 皮带轮/Pulley: A1/138
- 定线尺寸/Gauge line: 39.5
- 电压/Voltage: 24V
- 排量/Displacement: 155cc



KPRS715025026

- 适用车型/Applicable Vehicle: 通用型/UNIVERSAL VERSION
- 编号/Code: KPRS-7H15
- OE: SD8027
- 皮带轮/Pulley: PV8/119
- 定线尺寸/Gauge line: 50.1
- 电压/Voltage: 12V
- 排量/Displacement: 155cc



KPRS715025027

- 适用车型/Applicable Vehicle: 通用型/UNIVERSAL VERSION
- 编号/Code: KPRS-7H15
- OE: SD6039
- 皮带轮/Pulley: PV8/119
- 定线尺寸/Gauge line: 50.1
- 电压/Voltage: 24V
- 排量/Displacement: 155cc



KPRS715033035

- 适用车型/Applicable Vehicle: 达夫卡车/DAF
- 编号/Code: KPRS-7H15
- OE: 2013750
- 皮带轮/Pulley: PV8/132
- 定线尺寸/Gauge line: 61.5
- 电压/Voltage: 24V
- 排量/Displacement: 155cc



KPRS715001001

- 适用车型/Applicable Vehicle: 沃尔沃卡车/VOLVO
- 编号/Code: KPRS-7H15
- OE: 1401336
- 皮带轮/Pulley: PV2/149
- 定线尺寸/Gauge line: 39.5
- 电压/Voltage: 24V
- 排量/Displacement: 155cc



KPRS715001002

- 适用车型/Applicable Vehicle: 通用型/UNIVERSAL VERSION
- 编号/Code: KPRS-7H15
- OE: 82016158
- 皮带轮/Pulley: A2/125
- 定线尺寸/Gauge line: 46.5
- 电压/Voltage: 12V
- 排量/Displacement: 155cc



KPRS715001038

- 适用车型/Applicable Vehicle: 达夫CF系列/DAF CF
- 编号/Code: KPRS-7H15
- OE: 89139
- 皮带轮/Pulley: PV8/119
- 定线尺寸/Gauge line: 46.5
- 电压/Voltage: 24V
- 排量/Displacement: 155cc



KPRS715035037

- 适用车型/Applicable Vehicle: 通用型、上出口/UNIVERSAL VERSION
- 编号/Code: KPRS-7H15
- OE: 12304999
- 皮带轮/Pulley: A2/132
- 定线尺寸/Gauge line: 39.5
- 电压/Voltage: 12V
- 排量/Displacement: 155cc



KPRS715008031

- 适用车型/Applicable Vehicle: 雷诺卡车/RENAULT
- 编号/Code: KPRS-7H15
- OE: 7482492298
- 皮带轮/Pulley: PV8/132
- 定线尺寸/Gauge line: 56.5
- 电压/Voltage: 12V
- 排量/Displacement: 155cc



KPRS715018051

- 适用车型/Applicable Vehicle: 达夫卡车/DAF
- 编号/Code: KPRS-7H15
- OE: 1638737
- 皮带轮/Pulley: A1/133
- 定线尺寸/Gauge line: 28.8
- 电压/Voltage: 24V
- 排量/Displacement: 155cc



KPRS715008052

- 适用车型/Applicable Vehicle: 雷诺/RENAULT
- 编号/Code: KPRS-7H15
- OE: 20941036
- 皮带轮/Pulley: PV10/119
- 定线尺寸/Gauge line: 63.8
- 电压/Voltage: 24V
- 排量/Displacement: 155cc



KPRS715005029

- 适用车型/Applicable Vehicle: 斯堪尼亚/SCANIA
- 编号/Code: KPRS-7H15
- OE: 8FK351135981
- 皮带轮/Pulley: PV8/119
- 定线尺寸/Gauge line: 56.5
- 电压/Voltage: 24V
- 排量/Displacement: 155cc

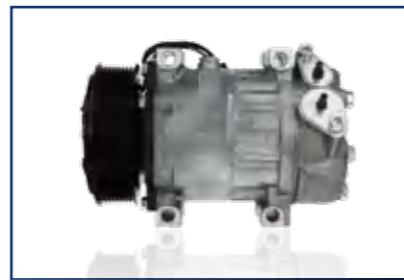

KPRS715030029

- 适用车型/Applicable Vehicle: 斯堪尼亚/SCANIA
- 编号/Code: KPRS-7H15
- OE: 1376998
- 皮带轮/Pulley: PV8/119
- 定线尺寸/Gauge line: 56.5
- 电压/Voltage: 24V
- 排量/Displacement: 155cc



KPRS715004017

- 适用车型/Applicable Vehicle: 标致P405/PEUGEOT P405
- 编号/Code: KPRS-7H15
- OE: SD8113
- 皮带轮/Pulley: PV6/119
- 定线尺寸/Gauge line: 46.5
- 电压/Voltage: 12V
- 排量/Displacement: 155cc



KPRS715001021

- 适用车型/Applicable Vehicle: /
- 编号/Code: KPRS-7H15
- OE: SD8253
- 皮带轮/Pulley: A2/132
- 定线尺寸/Gauge line: 39.5
- 电压/Voltage: 12V
- 排量/Displacement: 155cc



KPRS715001061

- 适用车型/Applicable Vehicle: 卡特彼勒/沃尔沃 CATERPILLAR/VOLVO
- 编号/Code: KPRS-7H15
- OE: /
- 皮带轮/Pulley: PV6/119
- 定线尺寸/Gauge line: 46.5
- 电压/Voltage: 12V
- 排量/Displacement: 155cc



KPRS715018053

- 适用车型/Applicable Vehicle: 达夫卡车/DAF
- 编号/Code: KPRS-7H15
- OE: 1864125
- 皮带轮/Pulley: A1/133
- 定线尺寸/Gauge line: 28.8
- 电压/Voltage: 24V
- 排量/Displacement: 155cc



KPRS514015024

- 适用车型/Applicable Vehicle: 东风自卸车、豪沃液罐车/DONGFENG DUMP TRUCK/HOWO TANKER TRUCK
- 编号/Code: KPRS-5S14
- OE: 1864125
- 皮带轮/Pulley: PV8/119
- 定线尺寸/Gauge line: 46.5
- 电压/Voltage: 24V
- 排量/Displacement: 138cc



KPRS514024043

- 适用车型/Applicable Vehicle: 跃进/现代/大运 YUEJIN/HYUNDAI/DAYUN
- 编号/Code: KPRS-5S14
- OE: /
- 皮带轮/Pulley: PV7/120
- 定线尺寸/Gauge line: 84.5
- 电压/Voltage: 24V
- 排量/Displacement: 138cc



KPRS715020062

- 适用车型/Applicable Vehicle: 纽荷兰/NEW HOLLAND
- 编号/Code: KPRS-7H15
- OE: /
- 皮带轮/Pulley: PV4/112
- 定线尺寸/Gauge line: 55
- 电压/Voltage: 12V
- 排量/Displacement: 155cc



KPRS715048021

- 适用车型/Applicable Vehicle: 道依茨/FAHR
- 编号/Code: KPRS-7H15
- OE: 72504984
- 皮带轮/Pulley: A2/132
- 定线尺寸/Gauge line: 39.5
- 电压/Voltage: 12V
- 排量/Displacement: 155cc



KPRS715009060

- 适用车型/Applicable Vehicle: 纽荷兰/NEW HOLLAND
- 编号/Code: KPRS-7H15
- OE: 87556183
- 皮带轮/Pulley: A2/132
- 定线尺寸/Gauge line: 39.5
- 电压/Voltage: 12V
- 排量/Displacement: 155cc



KPRS514026045

- 适用车型/Applicable Vehicle: 四川南骏/SICHUAN NANJUN
- 编号/Code: KPRS-5S14
- OE: /
- 皮带轮/Pulley: PV6/119
- 定线尺寸/Gauge line: 42.8
- 电压/Voltage: 24V
- 排量/Displacement: 138cc



KPRS514050112

- 适用车型/Applicable Vehicle: 南骏汽车/NANJUN
- 编号/Code: KPRS-5S14
- OE: /
- 皮带轮/Pulley: A2/132
- 定线尺寸/Gauge line: 39.5
- 电压/Voltage: 12V
- 排量/Displacement: 138cc



KPRS715062032

- 适用车型/Applicable Vehicle: 沃尔沃卡车/VOLVO
- 编号/Code: KPRS-7H15
- OE: DS100124
- 皮带轮/Pulley: PV8/176
- 定线尺寸/Gauge line: 56.5
- 电压/Voltage: 24V
- 排量/Displacement: 155cc



KPRS715021054

- 适用车型/Applicable Vehicle: 达夫卡车 CF系列/DAF CF
- 编号/Code: KPRS-7H15
- OE: 1685170
- 皮带轮/Pulley: PV7/136
- 定线尺寸/Gauge line: 57.5
- 电压/Voltage: 24V
- 排量/Displacement: 155cc



KPRS715024025

- 适用车型/Applicable Vehicle: JCB
- 编号/Code: KPRS-7H15
- OE: 32008562
- 皮带轮/Pulley: PV8/119
- 定线尺寸/Gauge line: 63.5
- 电压/Voltage: 12V
- 排量/Displacement: 155cc



KPRS715020056

- 适用车型/Applicable Vehicle: 纽荷兰/NEW HOLLAND
- 编号/Code: KPRS-7H15
- OE: 504221553
- 皮带轮/Pulley: PV4/119
- 定线尺寸/Gauge line: 38.5
- 电压/Voltage: 12V
- 排量/Displacement: 155cc



KPRS715061006

- 适用车型/Applicable Vehicle: 斯堪尼亚/SCANIA
- 编号/Code: KPRS-7H15
- OE: /
- 皮带轮/Pulley: PV8/119
- 定线尺寸/Gauge line: 63.8
- 电压/Voltage: 24V
- 排量/Displacement: 155cc



KPRS715047038

- 适用车型/Applicable Vehicle: 通用型/UNIVERSAL VERSION
- 编号/Code: KPRS-7H15
- OE: 81619066012
- 皮带轮/Pulley: PV8/119
- 定线尺寸/Gauge line: 46.5
- 电压/Voltage: 24V
- 排量/Displacement: 155cc



KPRS715057073

- 适用车型/Applicable Vehicle: 卡特彼勒/CATERPILLAR
- 编号/Code: KPRS-7H15
- OE: 3729295
- 皮带轮/Pulley: PV12/126
- 定线尺寸/Gauge line: 75.7
- 电压/Voltage: 24V
- 排量/Displacement: 155cc



KPRS715007032

- 适用车型/Applicable Vehicle: 沃尔沃FH 02/VOLVO FH 02
- 编号/Code: KPRS-7H15
- OE: 84094705
- 皮带轮/Pulley: PV8/176
- 定线尺寸/Gauge line: 56.5
- 电压/Voltage: 24V
- 排量/Displacement: 155cc



KPRS715056064

- 适用车型/Applicable Vehicle: 卡特/CAT
- 编号/Code: KPRS-7H15
- OE: SD4498
- 皮带轮/Pulley: PV8/133
- 定线尺寸/Gauge line: 56.5
- 电压/Voltage: 12V
- 排量/Displacement: 155cc



KPRS715037074

- 适用车型/Applicable Vehicle: NEW HOLLAND
- 编号/Code: KPRS-7H15
- OE: 84279787
- 皮带轮/Pulley: PV8/153
- 定线尺寸/Gauge line: 61.5
- 电压/Voltage: 24V
- 排量/Displacement: 155cc



KPRS715007070

- 适用车型/Applicable Vehicle: 沃尔沃工程车/VOLVO
- 编号/Code: KPRS-7H15
- OE: 20721587
- 皮带轮/Pulley: PV8/176
- 定线尺寸/Gauge line: 56.5
- 电压/Voltage: 12V
- 排量/Displacement: 155cc



KPRS715008048

- 适用车型/Applicable Vehicle: 雷诺卡车/RENAULT
- 编号/Code: KPRS-7H15
- OE: 5010563567
- 皮带轮/Pulley: PV8/132
- 定线尺寸/Gauge line: 56.5
- 电压/Voltage: 24V
- 排量/Displacement: 155cc



KPRS715003003

- 适用车型/Applicable Vehicle: 沃尔沃/VOLVO
- 编号/Code: KPRS-7H15
- OE: SD4270
- 皮带轮/Pulley: PV8/119
- 定线尺寸/Gauge line: 61.5
- 电压/Voltage: 24V
- 排量/Displacement: 155cc



KPRS715042048

- 适用车型/Applicable Vehicle: 沃尔沃卡车/VOLVO
- 编号/Code: KPRS-7H15
- OE: /
- 皮带轮/Pulley: PV8/132
- 定线尺寸/Gauge line: 46.5
- 电压/Voltage: 24V
- 排量/Displacement: 155cc

产品介绍

Product Introduction



福特、重汽系列 选用型号

FORD&CNHTC SERIES SELECTION MODEL

在乎舒适、可靠、节能，就用康普瑞 & 康普瑞森压缩机



KPRS717037037

- 适用车型/Applicable Vehicle: 林肯领航员3.5L
Lincoln Navigator 3.5L
- 型号/Model: KPRS-7SE17
- OE: GV6119D629GB
- 皮带轮/Pulley: PV4/108
- 电压/Voltage: 12V
- 排量/Displacement: 170.5cc



KPRS717056057

- 适用车型/Applicable Vehicle: 福特全顺2.2/Transit 310 2.0
Ford Transit 2.2/Transit 310 2.0
- 型号/Model: KPRS-VS17
- OE: E1GH19D629FC
- 皮带轮/Pulley: PV6/108
- 电压/Voltage: 12V
- 排量/Displacement: 170.5cc



KPRS717057057

- 适用车型/Applicable Vehicle: 蒙迪欧2.0
Mondeo 2.0
- 型号/Model: KPRS-VS17
- OE: DGH919D629FD
- 皮带轮/Pulley: PV6/108
- 电压/Voltage: 12V
- 排量/Displacement: 170.5cc



KPRS717076034

- 适用车型/Applicable Vehicle: 国产锐界/18款林肯/13款蒙迪欧2.0T
Ford Edge/Fusion/Lincoln MKZ
- 型号/Model: KPRS-7SE17
- OE: 198356
- 皮带轮/Pulley: PV4/108
- 电压/Voltage: 12V
- 排量/Displacement: 170.5cc



KPRS717036037

- 适用车型/Applicable Vehicle: 18款金牛座
Taurus 2018
- 型号/Model: KPRS-7SE17
- OE: /
- 皮带轮/Pulley: PV4/108
- 电压/Voltage: 12V
- 排量/Displacement: 170.5cc



KPRS717034034

- 适用车型/Applicable Vehicle: 林肯MKC 2.0T
Lincoln MKC 2.0T
- 型号/Model: KPRS-7SE17
- OE: /
- 皮带轮/Pulley: PV4/108
- 电压/Voltage: 12V
- 排量/Displacement: 170.5cc



KPR-1287

- 适用车型/Applications: 中国重汽U75
SINOTRUK WEICHAI U75
- OE: /
- 皮带轮/Pulley: PV6/110
- 电压/Voltage: 12V



KPR-1299

- 适用车型/Applications: 中国重汽皮卡
SINOTRUK
- OE: /
- 皮带轮/Pulley: PV6/110
- 电压/Voltage: 12V



KPR-1275

- 适用车型/Applications: 中国重汽U70/君马D50
SINOTRUK WEICHAI U70
- OE: /
- 皮带轮/Pulley: PV5/110
- 电压/Voltage: 12V



KPR-1131

- 适用车型/Applications: 福特嘉年华
FORD FIESTA VI 1.4 1.6 TDCI
- OE: 1514842/5212102
- 皮带轮/Pulley: PV6/118
- 电压/Voltage: 12V



KPR-1133

- 适用车型/Applications: 福特-蒙迪欧/马2 (03-07)
FORD FUSION
MAZDA 2 98'-12'
- OE: 1141327
- 皮带轮/Pulley: PV6/97
- 电压/Voltage: 12V



KPR-1135

- 适用车型/Applications: 福特嘉年华1.3L
FORD FIESTA 1.3L
- OE: 1141327/1405818/29BYU19D629AA/
2S6119D629AC
- 皮带轮/Pulley: PV6/97
- 电压/Voltage: 12V



KPR-1269

- 适用车型/Applications: 福特蒙迪欧2.5L
FORD MONDEO III 2.5 2002-2007
- OE: 10-160-01026
- 皮带轮/Pulley: PV6/100
- 电压/Voltage: 12V



KPR-1284

- 适用车型/Applications: 福特蒙迪欧 00-07(可替代B086-D)
FORD MONDEO 2.5
- OE: 1433094/XS7H19497AC/1S7H19D629
DE/4336112/4100562/4032669/1S7H19D6
29DC/RXS7H19D629BA
- 皮带轮/Pulley: PV6/110
- 电压/Voltage: 12V



KPR-1138

- 适用车型/Applications: 福特
FORD
- OE: /
- 皮带轮/Pulley: PV6/97
- 电压/Voltage: 12V



KPR-1134

- 适用车型/Applications: 福特嘉年华/蒙迪欧/福克斯/进口捷豹
FORD FIESTA/MONDEO/FOCUS/
JAGUAR (IMPORT)
- OE: /
- 皮带轮/Pulley: PV6/97
- 电压/Voltage: 12V



KPR-1240

- 适用车型/Applications: 中国重汽U70
SINOTRUK WEICHAI U70
- OE: /
- 皮带轮/Pulley: PV5/110
- 电压/Voltage: 12V

产品介绍

Product Introduction



在乎舒适、可靠、节能，就用康普瑞 & 康普瑞森压缩机

广汽、吉利系列 选用型号

GAC、GEELY SERIES SELECTION MODEL



KPR-8357

- 适用车型/Applications: 广汽传祺GA3/GS4 长脚
GAC TRUMPCHI GA3/GS4
- OE: /
- 皮带轮/Pulley: PV6/95
- 电压/Voltage: 12V



KPR-9642

- 适用车型/Applications: 吉奥R12
GAC GONOW R12
- OE: /
- 皮带轮/Pulley: A1/114
- 电压/Voltage: 12V



KPR-1201

- 适用车型/Applications: 广汽长丰CP2
GAC CHANGFENG CP2
- OE: /
- 皮带轮/Pulley: PV5/110
- 电压/Voltage: 12V



KPR-1218

- 适用车型/Applications: 长丰CP2
GAC CHANGFENG CP2
- OE: /
- 皮带轮/Pulley: PV6/118
- 电压/Voltage: 12V



KPR-1414

- 适用车型/Applications: 吉奥SUV
GAC GONOW SUV
- OE: /
- 皮带轮/Pulley: A2/128
- 电压/Voltage: 12V



KPR-83157

- 适用车型/Applications: 传祺GS3 短脚
GAC TRUMPCHI GS3
- OE: /
- 皮带轮/Pulley: PV6/95
- 电压/Voltage: 12V



KPR-83155

- 适用车型/Applications: 广汽23款传祺影豹
GAC TRUMPCHI YINGBAO 2023
- OE: /
- 皮带轮/Pulley: PV6/100
- 电压/Voltage: 12V



KPR-9651

- 适用车型/Applications: 广汽吉奥
GAC GONOW
- OE: /
- 皮带轮/Pulley: PV4/100
- 电压/Voltage: 12V



KPRS716002002

- 适用车型/Applicable Vehicle: 传祺 GS8/GA8/Trumpchi GS8/GA8
- 型号/Model: KPRS-7C16
- OE: 8110004BAL0101
- 皮带轮/Pulley: PV6/110
- 电压/Voltage: 12V
- 排量/Displacement: 160.5cc



KPRS716505505

- 适用车型/Applicable Vehicle: 广汽传祺GS4/Trumpchi GS4
- 型号/Model: KPRS-7V16
- OE: /
- 皮带轮/Pulley: PV6/110
- 电压/Voltage: 12V
- 排量/Displacement: 160.5CC



KPRS716001001

- 适用车型/Applicable Vehicle: 传祺GM7/GM6 GS5 19款传祺GM6 1.5T Trumpchi GM7/GM6 GAC GM6 1.5T 2019
- 型号/Model: KPRS-7C16
- OE: /
- 皮带轮/Pulley: PV6/110
- 电压/Voltage: 12V
- 排量/Displacement: 160.5cc



KPRS614007007

- 适用车型/Applicable Vehicle: 吉利博越/博瑞1.8T/Geekt ATLAS 1.8T
- 型号/Model: KPRS-6CVC
- OE: /
- 皮带轮/Pulley: PV6/115
- 电压/Voltage: 12V
- 排量/Displacement: 133cc



KPRS613049050

- 适用车型/Applicable Vehicle: 2020款 沃尔沃S60 2.0 2020 VOLVO S60 2.0
- 型号/Model: KPRS-VCS14
- OE: P31497908
- 皮带轮/Pulley: PV3/110 PV7/120
- 电压/Voltage: 12V
- 排量/Displacement: 133CC



KPRS717075050

- 适用车型/Applicable Vehicle: 沃尔沃XC60/2017-2022 VOLVO S60 2.0 2017-2022
- 型号/Model: KPRS-7SE17
- OE: P32130691
- 皮带轮/Pulley: PV3/110 PV7/120
- 电压/Voltage: 12V
- 排量/Displacement: 170.5CC



KPR-1434

- 适用车型/Applications: 沃尔沃740/940 I/940II/960I VOLVO 740/940 I/940II/960I
- OE: 9805081072
- 皮带轮/Pulley: PV8/119
- 电压/Voltage: 24V



KPR-96112

- 适用车型/Applications: 吉利帝豪EC7 GEELY EMGRAND EC7
- OE: /
- 皮带轮/Pulley: PV6/125
- 电压/Voltage: 12V



KPR-96160

- 适用车型/Applications: 吉利远景/帝豪EC715/EC718/海景 GEELY VISION/EMGRAN DEC715/EC718/SEAVIEW
- OE: /
- 皮带轮/Pulley: PV6/100
- 电压/Voltage: 12V



KPR-1109

- 适用车型/Applications: 吉利X3/X6 新帝豪 GEELY X3/X6 NEW EMGRAND
- OE: /
- 皮带轮/Pulley: PV6/107.7
- 电压/Voltage: 12V



KPRS717051051

- 适用车型/Applicable Vehicle: 17款沃尔沃XC90/17款沃尔沃亚太S90 Volvo s60 s80 II v70 III xc60
- 型号/Model: KPRS-PXC16
- OE: P31404446
- 皮带轮/Pulley: PV6/120
- 电压/Voltage: 12V
- 排量/Displacement: 170.5cc



KPRS613062062

- 适用车型/Applicable Vehicle: 吉利23款 博越L/领克1.5T GEELYBOYUEL 2023LYNK & CO 1.5T
- 型号/Model: KPRS-VCS14
- OE: /
- 皮带轮/Pulley: PV6/110
- 电压/Voltage: 12V
- 排量/Displacement: 133cc



KPR-96205

- 适用车型/Applications: 吉利远程锋锐F3 1.6L GEELY YUANCHENG FENGRUI F3 1.6L
- OE: /
- 皮带轮/Pulley: PV5/100
- 电压/Voltage: 12V



KPR-8317

- 适用车型/Applications: 吉利远景X1 GEELY VISION X1
- OE: /
- 皮带轮/Pulley: PV6/100
- 电压/Voltage: 12V



KPRS613049049

- 适用车型/Applicable Vehicle: 领克01 02 03/17款V40 1.5T 15-20款XC60 V60 LYNK & Co 01/02/03 Volvo S60 V60 XC40 XC60 2.0 2019
- 型号/Model: KPRS-VCS14
- OE: P31449067/P32260849
- 皮带轮/Pulley: PV6/120
- 电压/Voltage: 12V
- 排量/Displacement: 133CC

产品介绍

Product Introduction



在乎舒适、可靠、节能，就用康普瑞 & 康普瑞森压缩机

长城系列

选用型号

GWM SERIES SELECTION MODEL



KPR-8337

- 适用车型/Applications: 长城哈弗M4
HAVAL M4
- OE: /
- 皮带轮/Pulley: PV4/105
- 电压/Voltage: 12V



KPR-9620

- 适用车型/Applications: 长城炫丽/酷熊/C30
GREAT WALL FLORID /
COOLBEAR / C30
- OE: 8103200-S16
- 皮带轮/Pulley: PV4/118
- 电压/Voltage: 12V



KPR-9622

- 适用车型/Applications: 长城迪尔
GREAT WALL DEER
- OE: /
- 皮带轮/Pulley: A1/117
- 电压/Voltage: 12V



KPR-9635

- 适用车型/Applications: 长城精灵/炫丽
GREAT WALL PERI / FLORID
- OE: /
- 皮带轮/Pulley: PV4/110
- 电压/Voltage: 12V



KPR-1205

- 适用车型/Applications: 长城迪尔
GREAT WALL DEER
- OE: /
- 皮带轮/Pulley: A2/132
- 电压/Voltage: 12V



KPR-1206

- 适用车型/Applications: 长城C50
GREAT WALL C50
- OE: /
- 皮带轮/Pulley: PV6/Φ110
- 电压/Voltage: 12V



KPR-12106

- 适用车型/Applications: 长城风骏5 4PK
GREAT WALL WINGLE 5 4PK
- OE: JSR12T404002
- 皮带轮/Pulley: PV4/110
- 电压/Voltage: 12V



KPR-1431

- 适用车型/Applications: 哈弗H6
HAVAL H6
- OE: /
- 皮带轮/Pulley: PV4/110
- 电压/Voltage: 12V



KPR-1223

- 适用车型/Applications: 长城哈弗H6
HAVAL H6
- OE: /
- 皮带轮/Pulley: PV6/118
- 电压/Voltage: 12V



KPR-1405

- 适用车型/Applications: 长城风骏K2 4PK GREAT WALL WINGLE K2 4PK
- OE: JSS14D401023
- 皮带轮/Pulley: PV4/118
- 电压/Voltage: 12V



KPR-1266

- 适用车型/Applications: 长城C50 4PK GREAT WALL C50 4PK
- OE: /
- 皮带轮/Pulley: PV4/110
- 电压/Voltage: 12V



KPR-1401

- 适用车型/Applications: 长城迪尔 GREAT WALL DEER
- OE: /
- 皮带轮/Pulley: PV6/118
- 电压/Voltage: 12V



KPR-1409

- 适用车型/Applications: 长城风骏K2/双A槽 GREAT WALL WINGLE K2 / DUAL A-GROOVE
- OE: /
- 皮带轮/Pulley: A2/128
- 电压/Voltage: 12V



KPR-1402

- 适用车型/Applications: 长城迪尔6PK GREAT WALL DEER 6PK
- OE: /
- 皮带轮/Pulley: PV6/118
- 电压/Voltage: 12V



KPR-1270

- 适用车型/Applications: 哈弗H6青春版 HAVAL H6 YOUTH EDITION
- OE: 8103100ASY02A
- 皮带轮/Pulley: PV6/110
- 电压/Voltage: 12V



KPR-1297

- 适用车型/Applications: 哈弗H6青春版 HAVAL H6 YOUTH EDITION
- OE: 8103100XKZ1DA
- 皮带轮/Pulley: PV6/φ110
- 电压/Voltage: 12V



KPR-1411

- 适用车型/Applications: 长城赛铃 GREAT WALL SAILIN
- OE: /
- 皮带轮/Pulley: A2/128
- 电压/Voltage: 12V



KPR-9699

- 适用车型/Applications: 哈弗 M4 HAVAL M4
- OE: JSR097403002
- 皮带轮/Pulley: PV4/118
- 电压/Voltage: 12V



KPRS714013013

- 适用车型/Applicable Vehicle: 长城H6 HAVAL H6
- 编号/Code: KPRS-7CVC
- OE: /
- 皮带轮/Pulley: PV6/115
- 电压/Voltage: 12V
- 排量/Displacement: 170.5cc



KPRS614009009

- 适用车型/Applicable Vehicle: 哈弗H7 6PV14/魏牌VV5 17年2.0T HAVAL H7/WEY VV5 2.0T 2017
- 编号/Code: KPRS-6CVC
- OE: /
- 皮带轮/Pulley: PV6/118
- 电压/Voltage: 12V
- 排量/Displacement: 133cc



KPRS614010010

- 适用车型/Applicable Vehicle: 哈弗H7 6PK 4脚 20款H6第二代冠军版 HAVAL H7 H6 SECOND GENERATION CHAMPION EDITION 2020
- 编号/Code: KPRS-6CVC
- OE: /
- 皮带轮/Pulley: PV6/110
- 电压/Voltage: 12V
- 排量/Displacement: 133cc

产品介绍

Product Introduction



本田系列 选用型号

HONDA SERIES SELECTION MODEL

在乎舒适、可靠、节能，就用康普瑞 & 康普瑞森压缩机



KPR-8362

- 适用车型/Applications: 本田凌派1.0 2018 HONDA CRIDER 1.0 2018
- OE: 1007604853/SANDEN:E3904
- 皮带轮/Pulley: PV5/118
- 电压/Voltage: 12V



KPR-8398

- 适用车型/Applications: 本田思域2005年款(海外版) HONDA CIVIC 2005
- OE: 16003527-101/16003527-102/16003527-103/16003527-104/38800-R1B-A01RM/38810R1AA01/38800R1BA01RM/38810-R1A-A01
- 皮带轮/Pulley: PV7/100
- 电压/Voltage: 12V



KPR-96128

- 适用车型/Applications: 本田CRV 2.4 08-15 HONDA CRV 2.4 08-15
- OE: SANDEN: 3775/3880RL6-G020/38810-RWC-A03
- 皮带轮/Pulley: PV7/100
- 电压/Voltage: 12V



KPR-96129

- 适用车型/Applications: 本田八代雅阁2.0L (CP1) HONDA ACCORD 2.0L 2008 (CP1)
- OE: 38800RZV-G022-M2/SANDEN:3766/38810RNAA02/38810RNAA01/38800RZ-VG020M2/38800RZVG023M2/38800R62H01
- 皮带轮/Pulley: PV7/112
- 电压/Voltage: 12V



KPR-96130

- 适用车型/Applications: 本田思域 2.0L (RE2) HONDA CRV 2.0L 12
- OE: SANDEN: 3795/38800RZ-VG023M2/38800RZVG021M2
- 皮带轮/Pulley: PV7/100
- 电压/Voltage: 12V



KPR-96138

- 适用车型/Applications: 本田12款思域 (FB2) HONDA JADE 2012
- OE: 388005M1 H011M2 SANDEN: 3721
- 皮带轮/Pulley: PV6/112
- 电压/Voltage: 12V



KPR-96144

- 适用车型/Applications: 本田九代雅阁2.0L (CR1) HONDA ACCORD 2.0L 2009
- OE: 3720
- 皮带轮/Pulley: PV6/103
- 电压/Voltage: 12V



KPR-96147

- 适用车型/Applications: 本田CRV 2.4 2015- HONDA CRV 2.4 2015-
- OE: 38810-RZYA01/38810RWCA03
- 皮带轮/Pulley: PV7/100
- 电压/Voltage: 12V



KPR-96164

- 适用车型/Applications: 东风本田思威 2.0L HONDA CR-V 2.0L
- OE: /
- 皮带轮/Pulley: PV7/100
- 电压/Voltage: 12V



KPR-6329

- 适用车型/Applications: 本田N-BOX HONDA N-BOX
- OE: 38810-R9G-004 33810-5Z1-004/03279T12211 SANDEN: 3800
- 皮带轮/Pulley: PV4/100
- 电压/Voltage: 12V



KPR-6341

- 适用车型/Applications: 东风本田思铂睿 2016款 HONDA BRIO 2014
- OE: A3851
- 皮带轮/Pulley: PV5/100
- 电压/Voltage: 12V



KPR-6364

- 适用车型/Applications: 本田-BOX N BOX G-L
- OE: 92600E514A/W18D2430923
- 皮带轮/Pulley: PV4/125
- 电压/Voltage: 12V



KPR-83100

- 适用车型/Applications: 本田锋范 HONDA JAZZ 1.3
- OE: /
- 皮带轮/Pulley: PV5/112
- 电压/Voltage: 12V



KPR-1112

- 适用车型/Applications: 本田缤智、XRV、14款飞度 HONDA DBA-GK3 HONDA FIT 1.3 2014
- OE: 38810-5R0-004/P16-0109591/SAN DEN: 3902STR08/B01N0G7TH0/PA SKU600754/665402411
- 皮带轮/Pulley: PV6/109
- 电压/Voltage: 12V



KPR-96170

- 适用车型/Applications: 本田思威 2003海外版 HONDA CR-V 2003 OVERSEAS EDITION (RE SERIES)
- OE: /
- 皮带轮/Pulley: PV7/100
- 电压/Voltage: 12V



KPR-83104

- 适用车型/Applications: 本田07款飞度 HONDA FIT 2007 HONDA JAZZ 08
- OE: SP0159861/38810RMEA01/3 8810PWAJ02
- 皮带轮/Pulley: PV5/112
- 电压/Voltage: 12V



KPR-8355

- 适用车型/Applications: 本田07款飞度 HONDA JAZZ 07
- OE: 38810RMEA02/6512834/202 2697AM
- 皮带轮/Pulley: PV5/112
- 电压/Voltage: 12V



KPR-8356

- 适用车型/Applications: 本田思迪 HONDA JAZZ 06-07' HONDA CITY 1.5L FIT
- OE: 38800-REJ-H011-M2/SAN DEN: 3416/38800RSHE010
- 皮带轮/Pulley: PV5/112
- 电压/Voltage: 12V

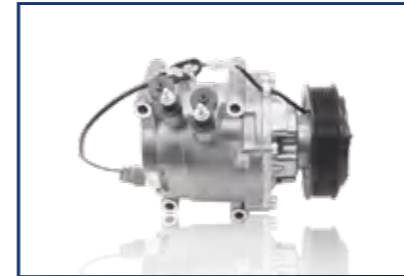

KPR-83101

- 适用车型/Applications: 本田思域MK7 HONDA CIVIC MK7
- OE: 38810P5M016/TR-SA09/38800PLMA021M2/38810PLMA 12/8810P5M006/38810PLAE01/20049 13AM/4984/4913
- 皮带轮/Pulley: PV6/112
- 电压/Voltage: 12V



KPR-83109

- 适用车型/Applications: 本田思域 VIIIHATCHBACK HONDA CIVIC VLLL HATCHBACK
- OE: 38810RSPE01
- 皮带轮/Pulley: PV7/100
- 电压/Voltage: 12V



KPR-96174

- 适用车型/Applications: 本田思域1.4 HONDA CIVIC 1.4L
- OE: /
- 皮带轮/Pulley: PV5/112
- 电压/Voltage: 12V



KPR-4310

- 适用车型/Applications: 本田 HONDA LIFE 2010 DBA-JC1 HONDA LIFE 2010 DBA-JC1
- OE: 38810RS8004
- 皮带轮/Pulley: PV5/100
- 电压/Voltage: 12V



KPRS614003001

- 适用车型/Applicable Vehicle: 思域2.0T/1.0T Civic 2.0T/1.0T
- 编号/Code: KPRS-6CVC
- OE: 388105BAA01
- 皮带轮/Pulley: PV7/110
- 电压/Voltage: 12V
- 排量/Displacement: 133cc



KPRS614002002

- 适用车型/Applicable Vehicle: 冠道2.0T AVANCIER 2.0T
- 编号/Code: KPRS-6CVC
- OE: 388105MSH03
- 皮带轮/Pulley: PV6/110
- 电压/Voltage: 12V
- 排量/Displacement: 133cc



KPRS614003003

- 适用车型/Applicable Vehicle: 本田19款 享域/思域1.0T HONDA ENVIX/CIVIC 1.0T 2019
- 编号/Code: KPRS-6CVC
- OE: /
- 皮带轮/Pulley: PV7/120
- 电压/Voltage: 12V
- 排量/Displacement: 133cc



KPRS613025025

- 适用车型/Applicable Vehicle: 十代雅阁1.5T 10th generation Accord 1.5T
- 型号/Model: KPRS-6SE13
- OE: 38810-6A0-A01
- 皮带轮/Pulley: PV7/110
- 电压/Voltage: 12V
- 排量/Displacement: 133CC



KPRS613028028

- 适用车型/Applicable Vehicle: 18讴歌TLX-L/2015款思铂睿2.4 18 ACURA TLX-L/2015 SPIRI 2.4
- 编号/Code: KPRS-6SE13
- OE: X1447160-8431
- 皮带轮/Pulley: PV7/120
- 电压/Voltage: 12V
- 排量/Displacement: 133cc



KPRS613050025

- 适用车型/Applicable Vehicle:
本田17款杰德
JADE 2017
- 编号/Code:KPRS-6SE13
- OE:447280-8510/447250-2335
- 皮带轮/Pulley:PV7/109
- 电压/Voltage:12V
- 排量/Displacement:133cc



KPRS614001001

- 适用车型/Applicable Vehicle:
冠道1.5T/16款思域1.5T/2020款 皓影1.5T AVANCIER 1.5T/Civic 1.5T 2016/BREEZE 1.5T 2020
- 编号/Code:KPRS-6CVC
- OE:388105AAA14 38810-5AA-A02
- 皮带轮/Pulley:PV7/110
- 电压/Voltage:12V
- 排量/Displacement:133cc

产品介绍

Product Introduction



现代起亚系列 选用型号

HYUNDAI/ KIA SERIES SELECTION MODEL

在乎舒适、可靠、节能，就用康普瑞 & 康普瑞森压缩机



KPRS613036021

- 适用车型/Applicable Vehicle: 2012款K2 (双控)
K2 2012
- 型号/Model: KPRS-VS14
- OE:97701H6100
- 皮带轮/Pulley: PV6/125
- 电压/Voltage: 12V
- 排量/Displacement: 133cc



KPRS616040040

- 适用车型/Applicable Vehicle: 2013款索兰托/14-15款现代途胜
HYUNDAI TUCSON 2010-2014
KIA SPORTAGE 2010-2014
- 型号/Model: KPRS-VS16
- OE:97701-2S000
- 皮带轮/Pulley: PV6/115
- 电压/Voltage: 12V
- 排量/Displacement: 160cc



KPRS616038003

- 适用车型/Applicable Vehicle: 起亚K5(四脚)/现代索纳塔八代
Kia K5/Modern Sonata VIII
- 型号/Model: KPRS-VS16
- OE:97701D7300
- 皮带轮/Pulley: PV6/115
- 电压/Voltage: 12V
- 排量/Displacement: 160cc



KPRS616045045

- 适用车型/Applicable Vehicle: 起亚 12-16款智跑 三脚
Kia Sportage for KX5 2.0 2012-2016
- 型号/Model: KPRS-DV16
- OE:97701-4T00
- 皮带轮/Pulley: PV6/125
- 电压/Voltage: 12V
- 排量/Displacement: 160cc



KPRS613021021

- 适用车型/Applicable Vehicle: 2017款悦动
Celesta,Elantra 2017
- 编号/Code:KPRS-6SE13
- OE:9701-2Y600
- 皮带轮/Pulley:PV6/125
- 电压/Voltage:12V
- 排量/Displacement:133cc



KPRS613023023

- 适用车型/Applicable Vehicle: 2019款K3内控
K3 2019
- 编号/Code:KPRS-6SE13
- OE:97701A5100
- 皮带轮/Pulley:PV6/115
- 电压/Voltage:12V
- 排量/Displacement:133cc



KPRS616037003

- 适用车型/Applicable Vehicle: 起亚K5(三脚)/八代索纳塔2.0
Kia K5
Yatsushiro Sonata 2.0
- 型号/Model: KPRS-VS16
- OE:97701-F2800
- 皮带轮/Pulley: PV6/115
- 电压/Voltage: 12V
- 排量/Displacement: 160cc



KPRS616038018

- 适用车型/Applicable Vehicle: 起亚K5(四脚)/现代索纳塔八代
Kia K5
Modern Sonata VIII
- 型号/Model: KPRS-VS16
- OE:97701-3V110
- 皮带轮/Pulley: PV6/110
- 电压/Voltage: 12V
- 排量/Displacement: 160cc



KPRS616039003

- 适用车型/Applicable Vehicle: 起亚K4(单控)
KIA K4
- 型号/Model: KPRS-VS16
- OE:97701-D3200
- 皮带轮/Pulley: PV6/115
- 电压/Voltage: 12V
- 排量/Displacement: 160cc



KPRS613038020

- 适用车型/Applicable Vehicle:
2015款K2 (单控)
K2 2015
- 型号/Model: KPRS-VS14
- OE:97701-1R100/97701-1W600
- 皮带轮/Pulley: PV6/125
- 电压/Voltage: 12V
- 排量/Displacement: 133cc



KPRS616029021

- 适用车型/Applicable Vehicle:
2013款起亚K3(双控)
K3 2013
- 型号/Model: KPRS-VS16
- OE:97701-J9000
- 皮带轮/Pulley: PV6/125
- 电压/Voltage: 12V
- 排量/Displacement: 160cc



KPRS616030020

- 适用车型/Applicable Vehicle:
2016款起亚K3(单控)
K3 2016
- 型号/Model: KPRS-VS16
- OE:97701-D3301
- 皮带轮/Pulley: PV6/125
- 电压/Voltage: 12V
- 排量/Displacement: 160cc



KPRS613020020

- 适用车型/Applicable Vehicle:
伊兰特朗动、2014款瑞纳
Elantra Avante、2014 Verna
- 编号/Code:KPRS-6SE13
- OE:97701-A5501
- 皮带轮/Pulley:PV6/125
- 电压/Voltage:12V
- 排量/Displacement:133cc

产品介绍

Product Introduction



五十铃系列

ISUZU SERIES SELECTION MODEL

选用型号



在乎舒适、可靠、节能，就用康普瑞 & 康普瑞森压缩机

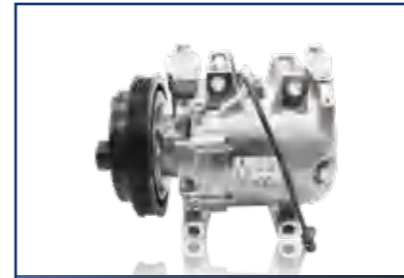

KPR-1428

- 适用车型/Applications: 五十铃D-MAX 2007 ISUZU D-MAX 2007
- OE: /
- 皮带轮/Pulley: PV4/134
- 电压/Voltage: 12V

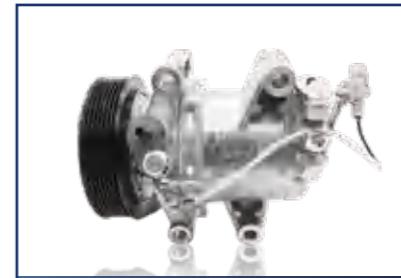

KPR-8373

- 适用车型/Applications: 五十铃D-MAX 2018 ISUZU D-MAX 2018
- OE: 92600F120A-S/898382610
- 皮带轮/Pulley: PV7/125
- 电压/Voltage: 12V



KPR-1424

- 适用车型/Applications: 五十铃D-MAX 单槽 ISUZU D-MAX 2.5 07-11' D-MAX CR14
- OE: 8980839230/8981992890/78972366371/8973694150
- 皮带轮/Pulley: A1/125
- 电压/Voltage: 12V



KPR-9681

- 适用车型/Applications: 五十铃竞技者 V6 3.2 ISUZU RODEO V6 3.2
- OE: 8972876410
- 皮带轮/Pulley: PV6/118
- 电压/Voltage: 12V



KPR-1253

- 适用车型/Applications: 五十铃D-MAX ISUZU D-MAX 2.5 2012
- OE: 8981028240/8981028241/926000C81/92600A070B
- 皮带轮/Pulley: A1/125
- 电压/Voltage: 12V

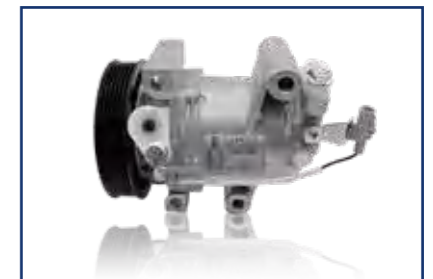

KPR-1260

- 适用车型/Applications: 五十铃D-MAX 2016 ISUZU D-MAX 1.9 2016
- OE: 92600D641A/8982568370/8983842610/92600F120A-S
- 皮带轮/Pulley: PV6/125
- 电压/Voltage: 12V



KPR-1247

- 适用车型/Applications: 五十铃搅拌机 ISUZU CONCRETE AGITATOR TRUCK
- OE: /
- 皮带轮/Pulley: B1/138
- 电压/Voltage: 24V



KPR-1423

- 适用车型/Applications: 五十铃D-MAX (黑金刚) ISUZU D-MAX 3.0 2005'
- OE: 8982002461/8973681210/8981992890/8973694150
- 皮带轮/Pulley: A2/Φ132
- 电压/Voltage: 12V

产品介绍

Product Introduction



江淮系列

JAC SERIES SELECTION MODEL

选用型号



在乎舒适、可靠、节能，就用康普瑞 & 康普瑞森压缩机



KPR-1403

- 适用车型/Applications: 江淮格尔发 JAC GELLY HEAVY-DUTY TRUCK
- OE: /
- 皮带轮/Pulley: PV6/118
- 电压/Voltage: 24V



KPR-1203

- 适用车型/Applications: 江淮大亮剑 JAC D-LIGHTNING SWORD SERIES (HEAVY DUTY)
- OE: /
- 皮带轮/Pulley: A1/128
- 电压/Voltage: 24V



KPR-1202

- 适用车型/Applications: 江淮小亮剑 JAC X-LIGHTNING SWORD SERIES (LIGHT DUTY)
- OE: /
- 皮带轮/Pulley: A2/128
- 电压/Voltage: 24V



KPR-96134

- 适用车型/Applications: 江淮好运轻卡 (4PK) JAC HAORYUN LIGHT TRUCK (4PK)
- OE: /
- 皮带轮/Pulley: PV4/107
- 电压/Voltage: 12V



KPRS113012001

- 适用车型/Applicable Vehicle: 江淮轻卡、5PK 12V
- 编号/Code: KPRS-10SA13
- OE: /
- 皮带轮/Pulley: PV5/122
- 电压/Voltage: 12V
- 排量/Displacement: 127cc



KPRS111001003

- 适用车型/Applicable Vehicle: 江淮好威轻卡
- 编号/Code: KPRS-10S11
- OE: /
- 皮带轮/Pulley: PV6/110
- 电压/Voltage: 12V
- 排量/Displacement: 116cc



KPRS111001008

- 适用车型/Applicable Vehicle: 江淮4PK JAC 4PK
- 编号/Code: KPRS-10S11
- OE: /
- 皮带轮/Pulley: PV4/107
- 电压/Voltage: 12V
- 排量/Displacement: 116cc



KPRS111006006

- 适用车型/Applicable Vehicle: 江淮好威轻卡 6PK 12V
- 编号/Code: KPRS-10S11
- OE: /
- 皮带轮/Pulley: PV6/110
- 电压/Voltage: 12V
- 排量/Displacement: 116cc



KPRS111001005

- 适用车型/Applicable Vehicle: 江淮好运轻卡单A
- 编号/Code: KPRS-10S11
- OE: /
- 皮带轮/Pulley: A1/110
- 电压/Voltage: 12V
- 排量/Displacement: 116cc

产品介绍

Product Introduction



马自达系列 选用型号

MAZDA SERIES SELECTION MODEL

在乎舒适、可靠、节能，就用康普瑞 & 康普瑞森压缩机



KPR-8334

- 适用车型/Applications: 马自达CX-3 2.0L MAZDA CX3&2 MAZDA DEMIO 2014-2016
- OE: D09W61450/T964038A/DBA-DJ3FS
- 皮带轮/Pulley: PV6/110
- 电压/Voltage: 12V



KPR-8340

- 适用车型/Applications: 马自达2/1.3L MAZDA 2 08'-15' 1.3
- OE: 92600C570A/DRZ8-61-450 052/DR08-61450/DR08-61052
- 皮带轮/Pulley: PV6/118
- 电压/Voltage: 12V



KPR-8341

- 适用车型/Applications: 马自达星骋 MAZDA 3 1.6
- OE: B44D61450/T904055B/BFF 5-61450/T917155A
- 皮带轮/Pulley: PV6/125
- 电压/Voltage: 12V



KPR-8345

- 适用车型/Applications: 马自达DEMIO 2011 MAZDA DEMIO 2011/MAZDA 501
- OE: D07A-61-450/L4500D07AA02/Z 0021341A/3070029367/L4500D07A A01/Z0015381A
- 皮带轮/Pulley: PV6/φ110
- 电压/Voltage: 12V

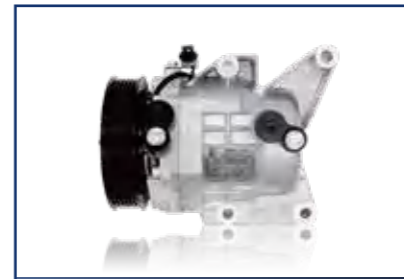

KPR-8350

- 适用车型/Applications: 马自达MX-5 MAZDA MX5/MIATA 2.0L
- OE: NE51-61450B/A4201114B00100/NE Y161450/NE5161450A/NE5161450B
- 皮带轮/Pulley: PV6/113
- 电压/Voltage: 12V



KPR-8364

- 适用车型/Applications: 马自达MX-5 MAZDA MX5/MIATA 2.0L (PULLEY 118MM)
- OE: 92600-00C33
- 皮带轮/Pulley: PV6/118
- 电压/Voltage: 12V



KPR-8386

- 适用车型/Applications: 马自达MX-5 MIATA MAZDA MX5 MIATA 2016-2019
- OE: 92600D391C/NA1J-61450
- 皮带轮/Pulley: PV6/110
- 电压/Voltage: 12V



KPR-1113

- 适用车型/Applications: 马自达昂克赛拉CX-5 MAZDA CX5 2.0
- OE: KD4561450/F500-JUBBA
- 皮带轮/Pulley: PV6/110
- 电压/Voltage: 12V



KPR-1114

- 适用车型/Applications: 马自达CX-3 MAZDA 2 15'/DEMIO 15'/CX-3 1.5/SKYACTIV
- OE: 92600D323A/D11R61450
- 皮带轮/Pulley: PV6/109
- 电压/Voltage: 12V



KPR-1207

- 适用车型/Applications: 马自达3 2.0L/MAZDA 3 1.6L 2004-2009 MAZDA 3 2.0L/2.3L 2006-2010 MAZDA 5 2.3L 2009 MAZDA 3 SPORT 2.0L
- OE: BP4S61K00/B32T61K00 H12A1AJ4EX-/H12A1AH4DX H12A1AH4FX/H12A1AN4GY CC2361K00A/CC4361450E
- 皮带轮/Pulley: PV5/100
- 电压/Voltage: 12V



KPR-1208

- 适用车型/Applications: 马自达3 1.6L MAZDA 3 1.4L / 1.6L ('03-) PETROL AXELA 1.6L (00- 07)
- OE: BP4K61K00/MZ70CM0810/H12A1AG4DY
- 皮带轮/Pulley: PV6/125
- 电压/Voltage: 12V



KPR-1286

- 适用车型/Applications: 海马福美来 1.8L MAZDA PROTÉGÉ
- OE: H12AOAH4JU/B25F61450B
- 皮带轮/Pulley: PV5/133
- 电压/Voltage: 12V



KPR-1217

- 适用车型/Applications: 马自达2 MAZDA 2
- OE: /
- 皮带轮/Pulley: PV6/117
- 电压/Voltage: 12V



KPR-1224

- 适用车型/Applications: 马自达6/MAZDA 6
- OE: GJ6A61K00/GJ6A61K00A/GJ6A61K00B/GJ6A61K00C/GJ6A61K00D/GJ6A61K00E/GJ6A61K00F/H12A1AF4A0/H12A1AF4DW
- 皮带轮/Pulley: PV6/125
- 电压/Voltage: 12V



KPR-1252

- 适用车型/Applications: 马自达3 2.0L MAZDA 3 1.8L/115MM (PULLEY)
- OE: H12A1AH4DX/CC2961450G/BP4S61K00/H12A1AJ4EX
- 皮带轮/Pulley: PV5/115
- 电压/Voltage: 12V



KPR-1259

- 适用车型/Applications: 马自达5 8PK MAZDA 5 DEPUIS 05' /3 DEPUIS 03' /6 DEPUIS 06'
- OE: GJ6F61K00/GJ6F61K00A/GJ6F61K00B/H12A1AE4DC/GJ6F61K00
- 皮带轮/Pulley: PV8/116
- 电压/Voltage: 12V



KPR-1264

- 适用车型/Applications: 马自达福美来 1.6L MAZDA 323 FAMILY
- OE: H12A0AA4DL/H12A0AX4EL-G/B26F-61-450/B25F61450B/B25F61K00A
- 皮带轮/Pulley: PV4/126
- 电压/Voltage: 12V



KPR-1282

- 适用车型/Applications: 马自达CX-7 08款 MAZDA CX7 08'
- OE: H12A1AAL4HX/H12A1AAL4A/H12A1AL4AO
- 皮带轮/Pulley: PV6/100
- 电压/Voltage: 12V



KPR-83103

- 适用车型/Applications: 马自达 MIATA MAZDA MIATA
- OE: 88310-YV020-D/B000775980 320088G
- 皮带轮/Pulley: PV6/110
- 电压/Voltage: 12V



KPR-1208A

- 适用车型/Applications: 马自达3 1.6L 环保口 MAZDA 3 1.6L STEPPED SUCTION
- OE: BP4K61K00/MZ70CM0810/H12A1AG4DY
- 皮带轮/Pulley: PV6/125
- 电压/Voltage: 12V



KPRS613035035

- 适用车型/Applicable Vehicle: 马自达3昂克塞拉 MAZDA 3 AXELA
- 型号/Model: KPRS-6SE13
- OE: BDGF61450
- 皮带轮/Pulley: PV6/110
- 电压/Voltage: 12V
- 排量/Displacement: 133CC

产品介绍

Product Introduction



在乎舒适、可靠、节能，就用康普瑞 & 康普瑞森压缩机

三菱系列

选用型号

MITSUBISHI SERIES SELECTION MODEL

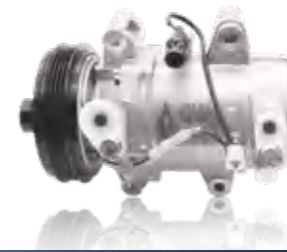

KPR-1121

- 适用车型/Applications: 三菱起森 MITSUBISHI
- OE: /
- 皮带轮/Pulley: PV4/116
- 电压/Voltage: 12V



KPR-1288

- 适用车型/Applications: 三菱中巴单A MITSUBISHI MSC90TA/CANTER/FUSO/ROSA BUS
- OE: AKC200A2738
- 皮带轮/Pulley: A1/143
- 电压/Voltage: 24V



KPR-1116

- 适用车型/Applications: 三菱 MITSUBISHI
- OE: /
- 皮带轮/Pulley: PV5/φ116
- 电压/Voltage: 12V



KPR-12104

- 适用车型/Applications: 三菱 MITSUBISHI
- OE: /
- 皮带轮/Pulley: A1/124
- 电压/Voltage: 24V



KPR-12105

- 适用车型/Applications: 三菱 MITSUBISHI
- OE: /
- 皮带轮/Pulley: PV6/97
- 电压/Voltage: 12V



KPR-1291

- 适用车型/Applications: 三菱 CANTER MITSUBISHI CANTER ROSA BUS FUSO
- OE: AKC200A277D/AKC200A270D/MK426704/MK509421
- 皮带轮/Pulley: PV6/φ117
- 电压/Voltage: 24V



KPR-83114

- 适用车型/Applications: 米拉奇 MITSUBISHI MIRAGE
- OE: /
- 皮带轮/Pulley: PV6/115
- 电压/Voltage: 12V



KPR-1118

- 适用车型/Applications: 三菱 TRITON5PK MITSUBISHI L200 2.4 15'-18' 5PK
- OE: 7813A673/92600D250C/7813A671/92600D250B/B150702289/7813B145/92600D251C
- 皮带轮/Pulley: PV5/116
- 电压/Voltage: 12V



KPR-1119

- 适用车型/Applications: 三菱起森 4PK MITSUBISHI TRITON 2015 4PK
- OE: 7813A671/92600D250B/644467-1119
- 皮带轮/Pulley: PV4/116
- 电压/Voltage: 12V



KPR-6347

- 适用车型/Applications: 三菱柯尔特 5PK MITSUBISHI COLT 5PK
- OE: AKC200A080A
- 皮带轮/Pulley: PV5/90.6
- 电压/Voltage: 12V



KPR-6349

- 适用车型/Applications: 三菱柯尔特 4PK MITSUBISHI COLT 1.6L (4PK)
- OE: AKC200A080
- 皮带轮/Pulley: PV4/90.6
- 电压/Voltage: 12V



KPR-6366

- 适用车型/Applications: 三菱MINICAB MITSUBISHI MINICAB 2012
- OE: 7813A607
- 皮带轮/Pulley: PV4/100
- 电压/Voltage: 12V



KPR-6367

- 适用车型/Applications: 三菱-MINICAB MITSUBISHI MINICAB
- OE: 7813A607
- 皮带轮/Pulley: PV4/100
- 电压/Voltage: 12V



KPR-6382

- 适用车型/Applications: 三菱蓝瑟 MITSUBISHI LANCER III 1.6 MITSUBISHI LANCE ASX
- OE: AKS200A208A/7813A480/AKS200A208/7813A750
- 皮带轮/Pulley: PV6/95
- 电压/Voltage: 12V



KPR-6386

- 适用车型/Applications: 三菱蓝瑟 2016 MITSUBISHI LANCER 2016
- OE: AKS200A208
- 皮带轮/Pulley: PV5/95
- 电压/Voltage: 12V



KPR-6396

- 适用车型/Applications: 三菱 EK MITSUBISHI EK CUSTOM 2014
- OE: /
- 皮带轮/Pulley: PV6/φ105
- 电压/Voltage: 12V



KPR-6397

- 适用车型/Applications: 三菱EK 2015款 MITSUBISHI EK SPACE 2015
- OE: T59469AA/7813A848
- 皮带轮/Pulley: PV6/115
- 电压/Voltage: 12V

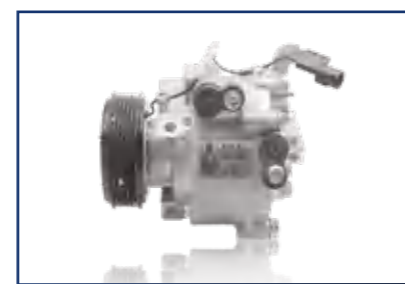

KPR-83113

- 适用车型/Applications: 三菱风迪思 1.8 (12-17) MITSUBISHI LANCER SPORT BACK 1.8 2012-2017
- OE: /
- 皮带轮/Pulley: PV6/95
- 电压/Voltage: 12V



KPR-8320

- 适用车型/Applications: 三菱翼神 MITSUBISHI LANCER-EX
- OE: AKS200A402A/AKS200A407C/AKS011H402C/AKS200A411G
- 皮带轮/Pulley: PV6/95
- 电压/Voltage: 12V



KPR-8339

- 适用车型/Applications: 三菱米拉奇 MITSUBISHI MIRAGE 2015
- OE: 7813A385/Z0015551B/815262/T77496B/7813A524/Z0019354A
- 皮带轮/Pulley: PV6/115
- 电压/Voltage: 12V



KPR-8359

- 适用车型/Applications: 三菱柯尔特1.6L MITSUBISHI COLT 1.6L (4PK) LANCER 08
- OE: 7813A057/7813A871/MR568860
- 皮带轮/Pulley: PV4/90.6
- 电压/Voltage: 12V



KPR-8360

- 适用车型/Applications: 三菱蓝瑟 MITSUBISHI COLT (5PK) SMART FORFOUR 454
- OE: AKC200A084/7813A057/7813A151
- 皮带轮/Pulley: PV5/90.6
- 电压/Voltage: 12V



KPR-8387

- 适用车型/Applications: 三菱I-MIEV MITSUBISHI-MIEV2010
- OE: AKC200A085/MN157931/851967N/C550-41/MTK226
- 皮带轮/Pulley: PV5/95
- 电压/Voltage: 12V



KPR-96177

- 适用车型/Applications: 三菱欧蓝德、戈蓝 MITSUBISHI OUTLANDER/GALANT
- OE: MR513148
- 皮带轮/Pulley: PV6/94
- 电压/Voltage: 12V



KPR-96192

- 适用车型/Applications: 三菱欧蓝德、戈蓝 MITSUBISHI OUTLANDER/GALANT
- OE: AKC200A204P
- 皮带轮/Pulley: PV5/94
- 电压/Voltage: 12V

产品介绍

Product Introduction

NISSAN SERIES 日产系列



在乎舒适、可靠、节能，就用康普瑞 & 康普瑞森压缩机

日产系列

选用型号

NISSAN SERIES SELECTION MODEL



KPR-8306

- 适用车型/Applications: 东风日产新阳光 NISSAN JUKE 11-13/NISMO 1.6 2016(7PK)/VERSA 1.6L
- OE: 92600-1KA1A/926006053R/926001KA1B/682-59126
- 皮带轮/Pulley: PV7/100
- 电压/Voltage: 12V



KPR-8312

- 适用车型/Applications: 日产新玛驰、劲客 NISSAN MICRA IV 1.2 10-19
- OE: 92600-1HC5A/926001HC5A/10018854/92600-3VA1D/926003VA1D/92600-3VA0D/926001HD1A
- 皮带轮/Pulley: PV7/100
- 电压/Voltage: 12V



KPR-8392

- 适用车型/Applications: 日产玛驰 03年-10年 NISSAN MICRA ADVAN CUBE
- OE: 92600AX80A/92600AX020/559508/92600AX84B/92600AX80B
- 皮带轮/Pulley: PV5/118
- 电压/Voltage: 12V



KPR-8393

- 适用车型/Applications: 日产-AD 2006年 NISSAN AD 2006-/NISSAN WINGROAD
- OE: 92600-WE410
- 皮带轮/Pulley: PV6/124
- 电压/Voltage: 12V



KPR-96102

- 适用车型/Applications: 日产骊威6PK NISSAN VERSO & CUBE (6PK)
- OE: 92600CJ67A
- 皮带轮/Pulley: PV6/115
- 电压/Voltage: 12V



KPR-96103

- 适用车型/Applications: 日产骏逸 NISSAN VERSA 1.8L NISSAN TIIDA 1.8 (6PK)
- OE: 92600CJ60A/92600CJ60B/92600CJ60C/4201A2900101/W06D1011515/92600-CJ61B/92600-CJ700/92600-CJ70A/92600-CJ70C/58887
- 皮带轮/Pulley: PV6/109
- 电压/Voltage: 12V



KPR-9621

- 适用车型/Applications: 东风日产颐达/骐达/启辰 NISSAN VERSA 1.6 (7PK) 2009-2010 CUBE 1.8L 2009-2012 VERSA 1.8L
- OE: 92600CJ73E/92600CJ73D/92600CJ73A/W10A1812098/A42011A2901501
- 皮带轮/Pulley: PV7/110
- 电压/Voltage: 12V



KPR-9631

- 适用车型/Applications: 东风日产老款骐达 NISSAN TIIDA 1.6 07 (7PK)
- OE: 92600-CJ70A/A42011A2901101/92600-CJ700/92600-CJ71B/A42011A2901200/92600-CJ70B/92600-CJ70C
- 皮带轮/Pulley: PV7/110
- 电压/Voltage: 12V



KPR-9669

- 适用车型/Applications: 日产09款骐达 NISSAN TIIDA 2008-2011
- OE: 926001JY7A/V09A1AC4BE/92600-ET00A
- 皮带轮/Pulley: PV7/110
- 电压/Voltage: 12V



KPR-12102

- 适用车型/Applications: 东风日产启辰 D60T DONGFENG NISSAN VENUCIA D60
- OE: /
- 皮带轮/Pulley: PV7/114
- 电压/Voltage: 12V



KPR-12103

- 适用车型/Applications: 东风日产启辰T70 1.4T DONGFENG NISSAN VENUCIA T70 1.4T
- OE: /
- 皮带轮/Pulley: PV5/110
- 电压/Voltage: 12V



KPR-1239

- 适用车型/Applications: 日产启辰T70 1.6L DONGFENG NISSAN VENUCIA T70 1.6T
- OE: /
- 皮带轮/Pulley: PV7/114
- 电压/Voltage: 12V



KPR-1254

- 适用车型/Applications: 日产纳瓦拉 NISSAN NAVARA D40 2.5/08-15 NISSAN PICKUP
- OE: 92600-EB70A/92600EB70A/92600-KH70A/92600KH70A
- 皮带轮/Pulley: PV7/115
- 电压/Voltage: 12V



KPR-1265

- 适用车型/Applications: 日产FRONTIER 05-15 NISSAN FRONTIER 05-11 XTERRA/SUZUKI EQUATOR
- OE: 92600-EA300/92600-EA01A/92600-EA30C/92600-EA30A/92600-EA31
- 皮带轮/Pulley: PV7/114
- 电压/Voltage: 12V



KPR-1268

- 适用车型/Applications: 东风日产启辰大V DONGFENG NISSAN VENUCIA V
- OE: JSR12T612086
- 皮带轮/Pulley: PV6/110
- 电压/Voltage: 12V



KPR-1280

- 适用车型/Applications: 日产启辰T70 2.0L (6PK) DONGFENG NISSAN VENUCIA T70 2.0T (6PK)
- OE: /
- 皮带轮/Pulley: PV6/110
- 电压/Voltage: 12V



KPR-1294

- 适用车型/Applications: 尼桑200SX NISSAN 200SX
- OE: 9260046L71/92600-2S400
- 皮带轮/Pulley: A1/135
- 电压/Voltage: 12V



KPR-8358

- 适用车型/Applications: 日产轩逸 6PK NISSAN NOTE 1.2 (6PK) NISSAN JUKE 1.5
- OE: 92600-3VB7B/926001-KA1B/WXNS028/926001HC0A/926001HC2B/CM108057/926001KC5A
- 皮带轮/Pulley: PV6/100
- 电压/Voltage: 12V



KPR-1438

- 适用车型/Applications: 日产 NISSAN NAVARA
- OE: 92600EB400/92600EB40E
- 皮带轮/Pulley: PV7/135
- 电压/Voltage: 12V



KPR-1439

- 适用车型/Applications: 日产 NISSAN ALMERA PRIMERA 96-20
- OE: 926002J204
- 皮带轮/Pulley: PV6/142
- 电压/Voltage: 12V



KPR-83146

- 适用车型/Applications: 日产 NISSAN MICRA ADVAN CUBE
- OE: /
- 皮带轮/Pulley: PV4/118
- 电压/Voltage: 12V



KPR-8326

- 适用车型/Applications: 日产 NISSAN NOTE 1.2 (6PK)
- OE: /
- 皮带轮/Pulley: PV6/100
- 电压/Voltage: 12V



KPRS613046046

- 适用车型/Applicable Vehicle: 13款天籁2.5/TEANA 2.5 2013
- 型号/Model: KPRS-VCS14
- OE: 926003TA1D
- 皮带轮/Pulley: PV6/115
- 电压/Voltage: 12V
- 排量/Displacement: 133cc



KPRS613051051

- 适用车型/Applicable Vehicle: 13款奇骏2.0/X-trail 2.0 2013
- 型号/Model: KPRS-VCS14
- OE: 92600-3TA5E
- 皮带轮/Pulley: PV6/115
- 电压/Voltage: 12V
- 排量/Displacement: 133CC



KPRS613045046

- 适用车型/Applicable Vehicle: 13款天籁2.0/Teana 2.0 2013
- 型号/Model: KPRS-VCS14
- OE: 92600-3TU5A
- 皮带轮/Pulley: PV6/115
- 电压/Voltage: 12V
- 排量/Displacement: 133cc



KPRS613045047

- 适用车型/Applicable Vehicle: 雷诺卡缤/Renault CAPTUR
- 型号/Model: KPRS-VCS14
- OE: 4471401140
- 皮带轮/Pulley: PV7/115
- 电压/Voltage: 12V
- 排量/Displacement: 133cc



KPRS714011012

- 适用车型/Applicable Vehicle: 逍客08款1.6L/NISSAN DUALIS 1.6L 2008
- 型号/Model: KPRS-7CVC
- OE: 82008484916
- 皮带轮/Pulley: PV7/115
- 电压/Voltage: 12V
- 排量/Displacement: 170.5cc



KPRS714011013

- 适用车型/Applicable Vehicle: 日产08款逍客2.0L/NISSAN DUALIS 2.0L 2008
- 型号/Model: KPRS-7CVC
- OE:92600ET00A
- 皮带轮/Pulley: PV6/115
- 电压/Voltage: 12V
- 排量/Displacement: 170.5cc



KPRS717054046

- 适用车型/Applicable Vehicle: 日产新逍客/奇骏2.0/NISSAN X-TRAIL 2.0
- 型号/Model: KPRS-7SE17
- OE:8200869742/92600-7817R
- 皮带轮/Pulley: PV6/115
- 电压/Voltage: 12V
- 排量/Displacement: 170.5cc



KPRS717054047

- 适用车型/Applicable Vehicle: 日产 13款逍客 1.6/NISSAN X-TRAIL 1.6 2013
- 型号/Model: KPRS-7SE17
- OE:92600-1DE0A
- 皮带轮/Pulley: PV7/115
- 电压/Voltage: 12V
- 排量/Displacement: 170.5cc



KPRS512007007

- 适用车型/Applicable Vehicle: 日产10款轩逸1.6/NISSAN SYLPHY 1.6 2010
- 型号/Model: KPRS-5VS12
- OE:/
- 皮带轮/Pulley: PV7/110
- 电压/Voltage: 12V
- 排量/Displacement: 123cc



KPRS512007008

- 适用车型/Applicable Vehicle: 日产10款轩逸2.0/NISSAN SYLPHY 2.0 2010
- 型号/Model: KPRS-5VS12
- OE:92600-1U60A
- 皮带轮/Pulley: PV6/110
- 电压/Voltage: 12V
- 排量/Displacement: 123cc



KPRS716004004

- 适用车型/Applicable Vehicle: 启辰星20款 VENUCIA 2020
- 型号/Model: KPRS-7C16
- OE:92600-1U60A
- 皮带轮/Pulley: PV6/115
- 电压/Voltage: 12V
- 排量/Displacement: 160.5cc

产品介绍

Product Introduction



在乎舒适、可靠、节能，就用康普瑞 & 康普瑞森压缩机

其它系列

选用型号

OTHER SERIES SELECTION MODELS

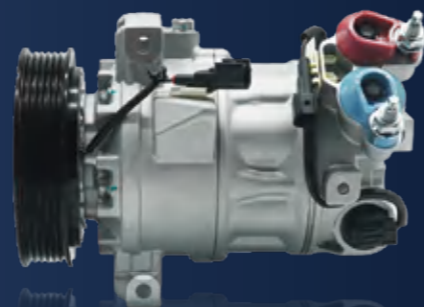

KPRS714001001

- 适用车型/Applicable Vehicle: 菲亚特2.3 (柴油)
FIAT 2.3 (diesel fuel)
- 编号/Code: KPRS-7CVC
- OE: 5802212928
- 皮带轮/Pulley: PV4/110
- 电压/Voltage: 12V
- 排量/Displacement: 170.5cc



KPRS714001002

- 适用车型/Applicable Vehicle: 菲亚特2.0 (汽油)
FIAT 2.0 (gasoline)
- 编号/Code: KPRS-7CVC
- OE: 447260-3020
- 皮带轮/Pulley: PV6/110
- 电压/Voltage: 12V
- 排量/Displacement: 170.5cc



KPRS717022026

- 适用车型/Applicable Vehicle: 路虎发现3 4.0
Land Rover Null3 4.0
- 编号/Code: KPRS-7SE17
- OE: 2W93-19D629-DE
- 皮带轮/Pulley: PV6/110
- 电压/Voltage: 12V
- 排量/Displacement: 170.5cc



KPR-8301

- 适用车型/Applications: FIAT UNO/PALIO FIRE
- OE: 51786321/W11J2020624
- 皮带轮/Pulley: PV5/115
- 电压/Voltage: 12V



KPR-8371

- 适用车型/Applications: 菲亚特500/阿巴斯/蓝旗亚1999
FIAT 500 2015/BRAVO IDEA/PAN DA PUNTO
- OE: SCSB06/46782669/51747318/71785268/1721833/DCP09004/447190-1640
- 皮带轮/Pulley: PV5/100
- 电压/Voltage: 12V



KPR-8376

- 适用车型/Applications: 菲亚特/蓝旗亚
FIAT PUNTO 1.3
- OE: SCSC06/46819144/51746931
- 皮带轮/Pulley: PV6/100
- 电压/Voltage: 12V



KPRS512005005

- 适用车型/Applicable Vehicle: 菲亚特 菲翔 1.4
FIAT Viaggio 1.4
- 编号/Code: KPRS-5CVC
- OE: 51883102
- 皮带轮/Pulley: PV5/110
- 电压/Voltage: 12V
- 排量/Displacement: 123cc



KPR-7201

- 适用车型/Applications: 小型轿车/商用车NULL
SMALL CAR/COMMERCIAL VEHICLE NULL
- OE: /
- 皮带轮/Pulley: PV4/107
- 电压/Voltage: 12V



KPR-1421

- 适用车型/Applications: 南骏杰瑞J30
NANJUN JIERUIJ30
- OE: /
- 皮带轮/Pulley: A2/132
- 电压/Voltage: 24V



KPR-9638

- 适用车型/Applications: 伊朗PRIDE SAIPA PRIDE(IRAN)
- OE: JSR09T401030
- 皮带轮/Pulley: A1/128
- 电压/Voltage: 12V



KPR-9639

- 适用车型/Applications: 伊朗PRIDE SAIPA PRIDE(IRAN)
- OE: /
- 皮带轮/Pulley: PV4/118
- 电压/Voltage: 12V



KPR-1404

- 适用车型/Applications: 华菱重卡 HUALINGHEAVY-DUTY TRUCK SERIES
- OE: /
- 皮带轮/Pulley: PV6/118
- 电压/Voltage: 24V



KPR-6308

- 适用车型/Applications: 外贸
- OE: /
- 皮带轮/Pulley: PV4/116
- 电压/Voltage: 12V



KPR-6313

- 适用车型/Applications: 外贸
- OE: /
- 皮带轮/Pulley: PV4/93
- 电压/Voltage: 24V



KPR-4308

- 适用车型/Applications: 单缸机 HORIZONTAL BAR ENGINE
- OE: /
- 皮带轮/Pulley: PV4/110
- 电压/Voltage: 12V



KPR-6303

- 适用车型/Applications: 双缸机 DUAL-CYLINDER ENGINE
- OE: /
- 皮带轮/Pulley: 单O槽/110
- 电压/Voltage: 12V



KPR-6304

- 适用车型/Applications: 海外
- OE: /
- 皮带轮/Pulley: A1/115.8
- 电压/Voltage: 12V



KPR-6302

- 适用车型/Applications: 利吉尔 LIGER JS 50 2016R.(FRANCE) SPORT 492 DCI
- OE: 700.08.311
- 皮带轮/Pulley: 单O槽/118
- 电压/Voltage: 12V



KPRS717080076

- 适用车型/Applicable Vehicle: 16款PORSCHE 718 BOXSTER 2.0 2.5 4.0 PORSCHE 718/Boxster 2.0 2.5 4.0 2016
- 编号/Code:KPRS-7SE17
- OE:9P1.820.803.B
- 皮带轮/Pulley:PV6/120
- 电压/Voltage:12V
- 排量/Displacement:170.5cc



KPRS717025005

- 适用车型/Applicable Vehicle: 卡宴4.5/Cayenne 4.5
- 编号/Code:KPRS-7SE17
- OE: 7L5820803
- 皮带轮/Pulley:PV7/120
- 电压/Voltage:12V
- 排量/Displacement:170.5cc



KPRS717025059

- 适用车型/Applicable Vehicle: 保时捷博斯特/911/918 Porsche Boxster /911/918
- 编号/Code:KPRS-7SE17
- OE:9A112601102
- 皮带轮/Pulley:PV6/120
- 电压/Voltage:12V
- 排量/Displacement:170.5cc



KPRS613059059

- 适用车型/Applicable Vehicle: 保时捷迈凯/MACAN
- 编号/Code:KPRS-6SE13
- OE:95B260805B
- 皮带轮/Pulley:PV6/120
- 电压/Voltage:12V
- 排量/Displacement:133cc



KPRS717059005

- 适用车型/Applicable Vehicle: 帕拉梅拉3.6/4.8 Panamera 3.6/4.8
- 型号/Model:KPRS-7SE17
- OE:4B3260805
- 皮带轮/Pulley:PV7/120
- 电压/Voltage:12V
- 排量/Displacement:170.5cc



KPRS717059059

- 适用车型/Applicable Vehicle: 帕拉梅拉3.0T(老款) Panamera 3.0T (old style)
- 型号/Model:KPRS-7SE17
- OE:9A112601105
- 皮带轮/Pulley:PV6/120
- 电压/Voltage:12V
- 排量/Displacement:170.5cc



KPRS616028026

- 适用车型/Applicable Vehicle: 红旗H7 Hong Qi H7
- 型号/Model:KPRS-6SE16
- OE:/
- 皮带轮/Pulley:PV6/110
- 电压/Voltage:12V
- 排量/Displacement:160cc



KPR-1222

- 适用车型/Applications: 东南菱帅
- OE: /
- 皮带轮/Pulley: PV5/110
- 电压/Voltage: 12V



KPR-6301

- 适用车型/Applications: 富路A7/C3-B/C2 FULU A7/C3-B/C2
- OE: /
- 皮带轮/Pulley: PV4/110
- 电压/Voltage: 12V



KPR-4304

- 适用车型/Applications: 富路增程车 FULU REEV PLATFORM (RANGE EXTENDER ELECTRIC VEHICLE)
- OE: 26699506/64304-8349
- 皮带轮/Pulley: PV4/110
- 电压/Voltage: 12V



KPR-9612

- 适用车型/Applications: 哈飞赛马 HAFEI SAIMA
- OE: /
- 皮带轮/Pulley: PV5/110
- 电压/Voltage: 12V



KPR-1278

- 适用车型/Applications: 奔腾B30、森雅R7(可替代106-BQH) FAW BESTUNE B30/SENIA R7
- OE: /
- 皮带轮/Pulley: PV6/110
- 电压/Voltage: 12V



KPR-1210

- 适用车型/Applications: 奇瑞优雅\奇瑞S22 CHERY ELEGANCE/CHERY S22
- OE: /
- 皮带轮/Pulley: PV4/110
- 电压/Voltage: 12V



KPRS716506003

- 适用车型/Applicable Vehicle: 奇瑞瑞虎1.5T 单控 Tiggo 1.5T
- 编号/Code: KPRS-7V16
- OE: 301000210AA
- 皮带轮/Pulley: PV6/110
- 电压/Voltage: 12V
- 排量/Displacement: 160.5cc



KPR-9611

- 适用车型/Applications: 奇瑞QQ CHERY QQ
- OE: /
- 皮带轮/Pulley: PV4/100
- 电压/Voltage: 12V



KPR-96131

- 适用车型/Applications: 依维柯物流王(可替代086-C16) IVECO CARGO KING LOGISTICS EDITION
- OE: /
- 皮带轮/Pulley: PV4/115
- 电压/Voltage: 12V



KPR-1271

- 适用车型/Applications: 依维柯都灵V(替代106-A) IVECO TURBO DAILY V
- OE: /
- 皮带轮/Pulley: PV4/115
- 电压/Voltage: 12V



KPR-6387

- 适用车型/Applications: TATA VISTA 1.3 2012-2016 TATA VISTA XENON
- OE: AKS200A201/287183400182/ AXD200A136
- 皮带轮/Pulley: PV6/95
- 电压/Voltage: 12V



KPRS716003003

- 适用车型/Applicable Vehicle: 奇瑞瑞虎8 1.6T/2.0T双控 FIAT Viaggio 1.4
- 编号/Code: KPRS-7C16
- OE: 301000210AA
- 皮带轮/Pulley: PV6/110
- 电压/Voltage: 12V
- 排量/Displacement: 160.5cc



KPR-9634

- 适用车型/Applications: 众泰2008/5008 ZOTYE 2008/5008
- OE: /
- 皮带轮/Pulley: PV5/110
- 电压/Voltage: 12V



KPR-1261

- 适用车型/Applications: 众泰T600 1.5T ZOTYE T600 1.5T
- OE: /
- 皮带轮/Pulley: PV5/100
- 电压/Voltage: 12V



KPR-8377

- 适用车型/Applications: 比亚迪F0/F3 1.0L BYD F0/F3 1.0L
- OE: /
- 皮带轮/Pulley: PV6/97
- 电压/Voltage: 12V



KPR-8378

- 适用车型/Applications: 比亚迪F3 1.5L BYD F3 1.5L
- OE: /
- 皮带轮/Pulley: PV5/97
- 电压/Voltage: 12V



KPR-1432

- 适用车型/Applications: 一汽解放小J6 FAW JIEFANG J6
- OE: /
- 皮带轮/Pulley: A1/133
- 电压/Voltage: 24V



KPR-9633

- 适用车型/Applications: 力帆520/川汽野马 LIFAN 520/CHUANQI YEMA
- OE: /
- 皮带轮/Pulley: PV4/100
- 电压/Voltage: 12V



KPR-1204

- 适用车型/Applications: 力帆520 LIFAN 520
- OE: /
- 皮带轮/Pulley: PV6/118
- 电压/Voltage: 12V



KPRS717038038

- 适用车型/Applicable Vehicle: 20款路虎卫士3.0 Land Rover Defender 3.0 2020
- 编号/Code: KPRS-7SE17
- OE: M8A2-19D62
- 皮带轮/Pulley: PV6/110
- 电压/Voltage: 12V
- 排量/Displacement: 170.5cc



KPRS717021025

- 适用车型/Applicable Vehicle:
路虎发现3 2.7柴油
Land Rover Null3 2.7 diesel fuel
- 编号/Code:KPRS-7SE17
- OE:4471808381
- 皮带轮/Pulley:PV8/110
- 电压/Voltage:12V
- 排量/Displacement:170.5cc



KPRS717021026

- 适用车型/Applicable Vehicle:
路虎发现4 2.7
Land Rover Null4 2.7
- 编号/Code:KPRS-7SE17
- OE:JPB000172
- 皮带轮/Pulley:PV6/110
- 电压/Voltage:12V
- 排量/Displacement:170.5cc



KPRS717022027

- 适用车型/Applicable Vehicle:
路虎发现4 4.0 V6
Land Rover Null4 4.0 V6
- 编号/Code:KPRS-7SE17
- OE:JPB500091
- 皮带轮/Pulley:PV6/100
- 电压/Voltage:12V
- 排量/Displacement:170.5cc



KPRS717042026

- 适用车型/Applicable Vehicle:
路虎发现3/Land Rover Null3
- 编号/Code:KPRS-7SE17
- OE:8H2219D623AA
- 皮带轮/Pulley:PV6/110
- 电压/Voltage:12V
- 排量/Displacement:170.5cc



KPRS616021021

- 适用车型/Applicable Vehicle:
JEEP自由客、指南者
JEEP Patriot、Compass
- 型号/Model:KPRS-6SE16
- OE:55111610AA
- 皮带轮/Pulley:PV6/120
- 电压/Voltage:12V
- 排量/Displacement:160cc



KPRS613027027

- 适用车型/Applicable Vehicle:
19款吉普自由侠1.3T
19 Renegade 1.3T
- 型号/Model:KPRS-6SE13
- OE:68439272AA
- 皮带轮/Pulley:PV5/110
- 电压/Voltage:12V
- 排量/Displacement:133cc



KPRS512006005

- 适用车型/Applicable Vehicle:
吉普 自由侠 1.4T/指南者 1.4T
JEEP Renegade 1.4T Compass 1.4T
- 型号/Model:KPRS-5SL12
- OE:51936443
- 皮带轮/Pulley:PV5/110
- 电压/Voltage:12V
- 排量/Displacement:123cc



KPRS614008008

- 适用车型/Applicable Vehicle:
双龙蒂维拉1.6
SSANGYONGTIVOLI 1.6
- 型号/Model:KPRS-6CVC
- OE:/
- 皮带轮/Pulley:PV5/110
- 电压/Voltage:12V
- 排量/Displacement:133cc



KPR-7220

- 适用车型/Applications:
大发
DAIHATSU HIET
- OE:/
- 皮带轮/Pulley:PV3/110
- 电压/Voltage: 12V



KPR-12118

- 适用车型/Applications:
协众虎威皮卡/中兴皮卡4PK
XIEZHONG HUWEI PICKUP /
ZHONGXING PICKUP 4PK
- OE:/
- 皮带轮/Pulley:PV4/118
- 电压/Voltage: 12V



KPR-83156

- 适用车型/Applications:
13款 伊苏拉/赛佳 BLM 1.6
EXORA 2013/ SAGA BLM 1.6
- OE:/
- 皮带轮/Pulley:PV6/112
- 电压/Voltage: 12V



KPR-12113

- 适用车型/Applications:
萨博
SAAB 900 1993-
- OE:/
- 皮带轮/Pulley:PV6/120
- 电压/Voltage: 12V



KPR-12114

- 适用车型/Applications:
中兴 20款虎威
ZHONGXING HUWEI 2020
- OE:/
- 皮带轮/Pulley:PV6/120
- 电压/Voltage: 12V

产品介绍

Product Introduction



标致系列

选用型号

PEUGEOT SERIES SELECTION MODELAS



在乎舒适、可靠、节能，就用康普瑞 & 康普瑞森压缩机



KPR-1101

- 适用车型/Applications: 标致301/雪铁龙爱丽舍 CITROEN C-ELYSEE 2012-2015 PEUGEOT 301 1.6L 2008
- OE: JSR11T602078/9676011680 / 9806599380/9810349980
- 皮带轮/Pulley: PV6/108
- 电压/Voltage: 12V



KPR-8351

- 适用车型/Applications: 标致108/雪铁龙C1 PEUGEOT 108 2017/CITROEN C1II 1.0 VTI (2014-)
- OE: 88310-YV010-D/B000776180 88310-YV010-B/88310YV010
- 皮带轮/Pulley: PV6/110
- 电压/Voltage: 12V



KPR-1141

- 适用车型/Applications: 标致 CITROËN BERLINGO 1.5 2018- (CONNECTOR IS DIFFERENCE WITH KPR-1101)
- OE: JSR11T602078/9676011680 / 9806599380/9810349980
- 皮带轮/Pulley: PV6/108
- 电压/Voltage: 12V



KPRS616047003

- 适用车型/Applicable Vehicle: 标致4008小轮 PEUGEOT 308 2015-2019 PEUGEOT 4008 2014-2020
- 型号/Model: KPRS-6SE16
- OE:437150-0200
- 皮带轮/Pulley: PV6/110
- 电压/Voltage: 12V
- 排量/Displacement: 160cc



KPRS616047047

- 适用车型/Applicable Vehicle: 标致4008大轮 PEUGEOT 308 2016-2019 PEUGEOT 4008 2014-2020
- 型号/Model: KPRS-6SE16
- OE:437150-0210
- 皮带轮/Pulley: PV6/119
- 电压/Voltage: 12V
- 排量/Displacement: 160cc



KPRS612004004

- 适用车型/Applicable Vehicle: 标致新307/雪铁龙凯旋 PEUGEOT 307 CITROËNC-TRIOMPHE
- 型号/Model: KPRS-6C12
- OE:1607424980
- 皮带轮/Pulley: PV6/119
- 电压/Voltage: 12V
- 排量/Displacement: 125cc



KPRS612501501

- 适用车型/Applicable Vehicle: 老标致206/307 PEUGEOT 206/307
- 型号/Model: KPRS-6V12
- OE:6453WK
- 皮带轮/Pulley: PV6/119
- 电压/Voltage: 12V
- 排量/Displacement: 125cc



KPRS612501502

- 适用车型/Applicable Vehicle: 标致 206/307 07-16款 宝马MINI PEUGEOT 206/207 BMW MINI2007-2016
- 型号/Model: KPRS-6V12
- OE:64522758433/64529223392
- 皮带轮/Pulley: PV6/110
- 电压/Voltage: 12V
- 排量/Displacement: 125cc



KPRS612501508

- 适用车型/Applicable Vehicle: 雪铁龙贝尔林戈 汽油款 PEUGEOTBERLINGO GASOLINEVERSION
- 型号/Model: KPRS-6V12
- OE:664526942501
- 皮带轮/Pulley: PV6/119
- 电压/Voltage: 12V
- 排量/Displacement: 125cc



KPRS509001001

- 适用车型/Applicable Vehicle:
东风雪铁龙
CITROEN
- 型号/Model: KPRS-5SE09
- OE:1608325980
- 皮带轮/Pulley: PV6/110
- 电压/Voltage: 12V
- 排量/Displacement: 89cc



KPRS716005005

- 适用车型/Applicable Vehicle:
雪铁龙14-16款DS6 1.6T
CITROEN DS6 1.6T2014-2016
- 型号/Model: KPRS-7C16
- OE:9678656080
- 皮带轮/Pulley: PV6/110
- 电压/Voltage: 12V
- 排量/Displacement: 160.5cc



KPRS716005006

- 适用车型/Applicable Vehicle:
东风标致13-14款 308、408、C4L
PEUGEOT 308/408/C4L 2013-2014
- 型号/Model: KPRS-7C16
- OE:/
- 皮带轮/Pulley: PV6/119
- 电压/Voltage: 12V
- 排量/Displacement: 160.5cc



KPRS716006006

- 适用车型/Applicable Vehicle:
雪铁龙C5 II 标致407、508
PEUGEOT 407/508 CITROEN C5 II
- 型号/Model: KPRS-7C16
- OE:664526942501
- 皮带轮/Pulley: PV6/119
- 电压/Voltage: 12V
- 排量/Displacement: 125cc



KPRS716007006

- 适用车型/Applicable Vehicle:
标致5008
PEUGEOT 5008
- 型号/Model: KPRS-7C16
- OE:1608473380
- 皮带轮/Pulley: PV6/119
- 电压/Voltage: 12V
- 排量/Displacement: 160.5cc



KPRS512003003

- 适用车型/Applicable Vehicle:
16-20款标致3008 1.5
18款雪铁龙 C5 1.5
PEUGEOT 5008 II CITROEN C5 1.5 2018
- 型号/Model: KPRS-5SL12
- OE:9829934580
- 皮带轮/Pulley: PV6/110
- 电压/Voltage: 12V
- 排量/Displacement: 123cc



KPRS512004004

- 适用车型/Applicable Vehicle:
标致2008/3008 雪铁龙C4
PEUGEOT 2008/3008
- 型号/Model: KPRS-5SL12
- OE:9834730080
- 皮带轮/Pulley: PV6/110
- 电压/Voltage: 12V
- 排量/Displacement: 123cc



KPRS614006006

- 适用车型/Applicable Vehicle:
21款 凡尔赛C5X 20款 雪铁龙C4 1.2
CITROEN C4 1.2 1.5 2020
- 型号/Model: KPRS-6CVC
- OE:9833718880
- 皮带轮/Pulley: PV6/110
- 电压/Voltage: 12V
- 排量/Displacement: 133cc

产品介绍

Product Introduction



冷藏系列 选用型号

REFRIGERATED SERIES



在乎舒适、可靠、节能，就用康普瑞 & 康普瑞森压缩机



KPRS121001003

- 适用车型/Applicable Vehicle: 冷藏车/Refrigerated trucks
- 编号/Code:KPRS-KP21
- OE:/
- 皮带轮/Pulley:B1/150
- 电压/Voltage:12V
- 排量/Displacement:215cc



KPRS121001005

- 适用车型/Applicable Vehicle: 冷藏车/Refrigerated trucks
- 编号/Code:KPRS-KP21
- OE:/
- 皮带轮/Pulley:B2/149
- 电压/Voltage:24V
- 排量/Displacement:215cc



KPRS121001007

- 适用车型/Applicable Vehicle: 冷藏车/Refrigerated trucks
- 编号/Code:KPRS-KP21
- OE:/
- 皮带轮/Pulley:B2/149
- 电压/Voltage:12V
- 排量/Displacement:215cc



KPRS121001011

- 适用车型/Applicable Vehicle: 冷藏车/Refrigerated trucks
- 编号/Code:KPRS-KP21
- OE:/
- 皮带轮/Pulley:8PK/127
- 电压/Voltage:24V
- 排量/Displacement:215cc



KPRS121001012

- 适用车型/Applicable Vehicle: 冷藏车/Refrigerated trucks
- 编号/Code:KPRS-KP21
- OE:/
- 皮带轮/Pulley:8PK/127
- 电压/Voltage:12V
- 排量/Displacement:215cc



KPRS121001013

- 适用车型/Applicable Vehicle: 冷藏车/Refrigerated trucks
- 编号/Code:KPRS-KP21
- OE:/
- 皮带轮/Pulley:6PK/137
- 电压/Voltage:24V
- 排量/Displacement:215cc



KPRS121001014

- 适用车型/Applicable Vehicle: 冷藏车/Refrigerated trucks
- 编号/Code:KPRS-KP21
- OE:/
- 皮带轮/Pulley:6PK/137
- 电压/Voltage:12V
- 排量/Displacement:215cc



KPRS121001016

- 适用车型/Applicable Vehicle: 冷藏车/Refrigerated trucks
- 编号/Code:KPRS-KP21
- OE:/
- 皮带轮/Pulley:8PK/137
- 电压/Voltage:12V
- 排量/Displacement:215cc



KPRS121001017

- 适用车型/Applicable Vehicle: 冷藏车/Refrigerated trucks
- 编号/Code:KPRS-KP21
- OE:/
- 皮带轮/Pulley:8PK/137
- 电压/Voltage:24V
- 排量/Displacement:215cc



KPRS121001018

- 适用车型/Applicable Vehicle: 冷藏车/Refrigerated trucks
- 编号/Code:KPRS-KP21
- OE:/
- 皮带轮/Pulley:8PK/137
- 电压/Voltage:12V
- 排量/Displacement:215cc



KPRS121001101

- 适用车型/Applicable Vehicle: 冷藏车/Refrigerated trucks
- 编号/Code:KPRS-KP21
- OE:/
- 皮带轮/Pulley:B1/150
- 电压/Voltage:24V
- 排量/Displacement:215cc



KPRS121001103

- 适用车型/Applicable Vehicle: 冷藏车/Refrigerated trucks
- 编号/Code:KPRS-KP21
- OE:/
- 皮带轮/Pulley:B1/150
- 电压/Voltage:12V
- 排量/Displacement:215cc



KPRS121001105

- 适用车型/Applicable Vehicle: 冷藏车/Refrigerated trucks
- 编号/Code:KPRS-KP21
- OE:/
- 皮带轮/Pulley:B2/149
- 电压/Voltage:24V
- 排量/Displacement:215cc



KPRS121001107

- 适用车型/Applicable Vehicle: 冷藏车/Refrigerated trucks
- 编号/Code:KPRS-KP21
- OE:/
- 皮带轮/Pulley:B2/149
- 电压/Voltage:12V
- 排量/Displacement:215cc



KPRS121001109

- 适用车型/Applicable Vehicle: 冷藏车/Refrigerated trucks
- 编号/Code:KPRS-KP21
- OE:/
- 皮带轮/Pulley:A2/145
- 电压/Voltage:24V
- 排量/Displacement:215cc



KPRS121001110

- 适用车型/Applicable Vehicle: 冷藏车/Refrigerated trucks
- 编号/Code:KPRS-KP21
- OE:/
- 皮带轮/Pulley:A2/145
- 电压/Voltage:12V
- 排量/Displacement:215CC



KPRS121001111

- 适用车型/Applicable Vehicle: 冷藏车/Refrigerated trucks
- 编号/Code:KPRS-KP21
- OE:/
- 皮带轮/Pulley:8PK/127
- 电压/Voltage:24V
- 排量/Displacement:215CC



KPRS121001112

- 适用车型/Applicable Vehicle: 冷藏车/Refrigerated trucks
- 编号/Code:KPRS-KP21
- OE:/
- 皮带轮/Pulley:8PK/127
- 电压/Voltage: 12V
- 排量/Displacement:215cc



KPRS121001113

- 适用车型/Applicable Vehicle: 冷藏车/Refrigerated trucks
- 编号/Code:KPRS-KP21
- OE:/
- 皮带轮/Pulley:6PK/137
- 电压/Voltage:24V
- 排量/Displacement:215cc



KPRS121001114

- 适用车型/Applicable Vehicle: 冷藏车/Refrigerated trucks
- 编号/Code:KPRS-KP21
- OE:/
- 皮带轮/Pulley:6PK/137
- 电压/Voltage:12V
- 排量/Displacement:215cc



KPRS121001115

- 适用车型/Applicable Vehicle: 冷藏车/Refrigerated trucks
- 编号/Code:KPRS-KP21
- OE:/
- 皮带轮/Pulley:8PK/137
- 电压/Voltage:24V
- 排量/Displacement:215cc



KPRS121001116

- 适用车型/Applicable Vehicle: 冷藏车/Refrigerated trucks
- 编号/Code:KPRS-KP21
- OE:/
- 皮带轮/Pulley:8PK/137
- 电压/Voltage:12V
- 排量/Displacement:215cc



KPRS121001117

- 适用车型/Applicable Vehicle: 冷藏车/Refrigerated trucks
- 编号/Code:KPRS-KP21
- OE:/
- 皮带轮/Pulley:8PK/137
- 电压/Voltage:24V
- 排量/Displacement:215cc



KPRS121001118

- 适用车型/Applicable Vehicle: 冷藏车/Refrigerated trucks
- 编号/Code:KPRS-KP21
- OE:/
- 皮带轮/Pulley:8PK/137
- 电压/Voltage:12V
- 排量/Displacement:215cc



KPRS121002105

- 适用车型/Applicable Vehicle: 冷藏车/Refrigerated trucks
- 编号/Code:KPRS-KP21
- OE:/
- 皮带轮/Pulley:B2/149
- 电压/Voltage:24V
- 排量/Displacement:215cc



KPRS121001001

- 适用车型/Applicable Vehicle: 冷藏车/Refrigerated trucks
- 编号/Code:KPRS-KP21
- OE:/
- 皮带轮/Pulley:B1/150
- 电压/Voltage:24V
- 排量/Displacement:215cc



KPRS121001002

- 适用车型/Applicable Vehicle: 冷藏车/Refrigerated trucks
- 编号/Code:KPRS-KP21
- OE:/
- 皮带轮/Pulley:B1/150
- 电压/Voltage:24V
- 排量/Displacement:215cc



KPRS121001015

- 适用车型/Applicable Vehicle: 冷藏车/Refrigerated trucks
- 编号/Code:KPRS-KP21
- OE:/
- 皮带轮/Pulley:8PK/137
- 电压/Voltage:24V
- 排量/Displacement:215cc



KPRS121001009

- 适用车型/Applicable Vehicle: 冷藏车/Refrigerated trucks
- 编号/Code:KPRS-KP21
- OE:/
- 皮带轮/Pulley:A2/145
- 电压/Voltage:24V
- 排量/Displacement:215cc



KPRS121002111

- 适用车型/Applicable Vehicle: 冷藏车/Refrigerated trucks
- 编号/Code:KPRS-KP21
- OE:/
- 皮带轮/Pulley:8PK/127
- 电压/Voltage:24V
- 排量/Displacement:215cc



KPRS121002112

- 适用车型/Applicable Vehicle: 冷藏车/Refrigerated trucks
- 编号/Code:KPRS-KP21
- OE:/
- 皮带轮/Pulley:8PK/127
- 电压/Voltage:12V
- 排量/Displacement:215cc



KPRS121002109

- 适用车型/Applicable Vehicle: 冷藏车/Refrigerated trucks
- 编号/Code:KPRS-KP21
- OE:/
- 皮带轮/Pulley:A2/145
- 电压/Voltage:24V
- 排量/Displacement:215cc



KPRS132101001

- 适用车型/Applicable Vehicle: 冷藏车/Refrigerated trucks
- 编号/Code:KPRS-KP32
- OE:/
- 皮带轮/Pulley:B2/158
- 电压/Voltage:24V
- 排量/Displacement:320cc



KPRS132102001

- 适用车型/Applicable Vehicle: 冷藏车/Refrigerated trucks
- 编号/Code:KPRS-KP32
- OE:/
- 皮带轮/Pulley:B2/158
- 电压/Voltage:24V
- 排量/Displacement:320cc



KPRS132103001

- 适用车型/Applicable Vehicle: 冷藏车/Refrigerated trucks
- 编号/Code:KPRS-KP32
- OE:/
- 皮带轮/Pulley:B2/158
- 电压/Voltage:24V
- 排量/Displacement:320cc



KPRS132104001

- 适用车型/Applicable Vehicle: 冷藏车/Refrigerated trucks
- 编号/Code:KPRS-KP32
- OE:/
- 皮带轮/Pulley:B2/158
- 电压/Voltage:24V
- 排量/Displacement:320cc



KPRS132101011

- 适用车型/Applicable Vehicle: 冷藏车/Refrigerated trucks
- 编号/Code:KPRS-KP32
- OE:/
- 皮带轮/Pulley:8PK/152
- 电压/Voltage:24V
- 排量/Displacement:320cc



KPRS132101012

- 适用车型/Applicable Vehicle: 冷藏车/Refrigerated trucks
- 编号/Code:KPRS-KP32
- OE:/
- 皮带轮/Pulley:A2/152
- 电压/Voltage:24V
- 排量/Displacement:320cc



KPRS132101013

- 适用车型/Applicable Vehicle: 冷藏车/Refrigerated trucks
- 编号/Code:KPRS-KP32
- OE:/
- 皮带轮/Pulley:B2/158
- 电压/Voltage:24V
- 排量/Displacement:320cc



KPRS132101016

- 适用车型/Applicable Vehicle: 冷藏车/Refrigerated trucks
- 编号/Code:KPRS-KP32
- OE:/
- 皮带轮/Pulley:6PK/152
- 电压/Voltage:24V
- 排量/Displacement:320cc



KPRS132101017

- 适用车型/Applicable Vehicle: 冷藏车/Refrigerated trucks
- 编号/Code:KPRS-KP32
- OE:/
- 皮带轮/Pulley:A2/152
- 电压/Voltage:12V
- 排量/Displacement:320cc



KPRS132107002

- 适用车型/Applicable Vehicle: 冷藏车/Refrigerated trucks
- 编号/Code:KPRS-KP32
- OE:/
- 皮带轮/Pulley:B2/158
- 电压/Voltage:24V
- 排量/Displacement:320cc



KPRS132101019

- 适用车型/Applicable Vehicle: 冷藏车/Refrigerated trucks
- 编号/Code:KPRS-KP32
- OE:/
- 皮带轮/Pulley:B2/158
- 电压/Voltage:12V
- 排量/Displacement:320cc



KPRS132102005

- 适用车型/Applicable Vehicle: 冷藏车/Refrigerated trucks
- 编号/Code:KPRS-KP32
- OE:/
- 皮带轮/Pulley:B2/158
- 电压/Voltage:12V
- 排量/Displacement:320cc



KPRS138001001

- 适用车型/Applicable Vehicle: 冷藏车/Refrigerated trucks
- 编号/Code:KPRS-KP38
- OE:/
- 皮带轮/Pulley:B2/158
- 电压/Voltage:24V
- 排量/Displacement:380cc



KPRS138002001

- 适用车型/Applicable Vehicle: 冷藏车/Refrigerated trucks
- 编号/Code:KPRS-KP38
- OE:/
- 皮带轮/Pulley:B2/158
- 电压/Voltage:24V
- 排量/Displacement:380cc



KPRS138003001

- 适用车型/Applicable Vehicle: 冷藏车/Refrigerated trucks
- 编号/Code:KPRS-KP38
- OE:/
- 皮带轮/Pulley:B2/158
- 电压/Voltage:24V
- 排量/Displacement:380cc



KPRS138001011

- 适用车型/Applicable Vehicle: 冷藏车/Refrigerated trucks
- 编号/Code:KPRS-KP38
- OE:/
- 皮带轮/Pulley:8PK/152
- 电压/Voltage:24V
- 排量/Displacement:380cc



KPRS511001001LC

- 适用车型/Applicable Vehicle: 冷藏车/Refrigerated trucks
- 编号/Code:KPRS-5S11
- OE:/
- 皮带轮/Pulley:A2/125
- 电压/Voltage:12V
- 排量/Displacement:108cc



KPRS511001003LC

- 适用车型/Applicable Vehicle: 冷藏车/Refrigerated trucks
- 编号/Code:KPRS-5S11
- OE:/
- 皮带轮/Pulley:PV8/119
- 电压/Voltage:12V
- 排量/Displacement:108cc



KPRS511002001LC

- 适用车型/Applicable Vehicle: 冷藏车/Refrigerated trucks
- 编号/Code:KPRS-5S11
- OE:/
- 皮带轮/Pulley:A2/125
- 电压/Voltage: 12V
- 排量/Displacement:108cc



KPRS511002003LC

- 适用车型/Applicable Vehicle: 冷藏车/Refrigerated trucks
- 编号/Code:KPRS-5S11
- OE:/
- 皮带轮/Pulley:PV8/119
- 电压/Voltage: 12V
- 排量/Displacement:108cc



KPRS514002001LC

- 适用车型/Applicable Vehicle: 冷藏车/Refrigerated trucks
- 编号/Code:KPRS-5S14
- OE:/
- 皮带轮/Pulley:A2/132
- 电压/Voltage: 12V
- 排量/Displacement:138cc



KPRS514002018LC

- 适用车型/Applicable Vehicle: 冷藏车/Refrigerated trucks
- 编号/Code:KPRS-5S14
- OE:/
- 皮带轮/Pulley:PV8/119
- 电压/Voltage:12V
- 排量/Displacement:138cc



KPRS514006001LC

- 适用车型/Applicable Vehicle: 冷藏车/Refrigerated trucks
- 编号/Code:KPRS-5S14
- OE:/
- 皮带轮/Pulley:A2/132
- 电压/Voltage:12V
- 排量/Displacement:138cc



KPRS514006018LC

- 适用车型/Applicable Vehicle: 冷藏车/Refrigerated trucks
- 编号/Code:KPRS-5S14
- OE:/
- 皮带轮/Pulley:PV8/119
- 电压/Voltage:12V
- 排量/Displacement:138cc



KPRS617001001

- 适用车型/Applicable Vehicle: 冷藏车/Refrigerated trucks
- 编号/Code:KPRS-KP16
- OE:/
- 皮带轮/Pulley:A2/135
- 电压/Voltage: 24V
- 排量/Displacement:162cc



KPRS617001002

- 适用车型/Applicable Vehicle: 冷藏车/Refrigerated trucks
- 编号/Code:KPRS-KP16
- OE:/
- 皮带轮/Pulley:PV8/119
- 电压/Voltage: 24V
- 排量/Displacement:162cc



KPRS617001003

- 适用车型/Applicable Vehicle: 冷藏车/Refrigerated trucks
- 编号/Code:KPRS-KP16
- OE:/
- 皮带轮/Pulley:A2/135
- 电压/Voltage: 12V
- 排量/Displacement:162cc



KPRS617001004

- 适用车型/Applicable Vehicle: 冷藏车/Refrigerated trucks
- 编号/Code:KPRS-KP16
- OE:/
- 皮带轮/Pulley:PV8/119
- 电压/Voltage: 12V
- 排量/Displacement:162cc



KPRS617001005

- 适用车型/Applicable Vehicle: 冷藏车/Refrigerated trucks
- 编号/Code:KPRS-KP16
- OE:/
- 皮带轮/Pulley:A2/135
- 电压/Voltage: 24V
- 排量/Displacement:162cc



KPRS617001006

- 适用车型/Applicable Vehicle: 冷藏车/Refrigerated trucks
- 编号/Code:KPRS-KP16
- OE:/
- 皮带轮/Pulley:A2/135
- 电压/Voltage: 12V
- 排量/Displacement:162cc



KPRS617001007

- 适用车型/Applicable Vehicle: 冷藏车/Refrigerated trucks
- 编号/Code:KPRS-KP16
- OE:/
- 皮带轮/Pulley:PV8/119
- 电压/Voltage: 24V
- 排量/Displacement:162cc



KPRS617001008

- 适用车型/Applicable Vehicle: 冷藏车/Refrigerated trucks
- 编号/Code:KPRS-KP16
- OE:/
- 皮带轮/Pulley:PV8/119
- 电压/Voltage: 12V
- 排量/Displacement:162cc



KPRS617002008

- 适用车型/Applicable Vehicle: 冷藏车/Refrigerated trucks
- 编号/Code:KPRS-KP16
- OE:/
- 皮带轮/Pulley:PV8/119
- 电压/Voltage: 12V
- 排量/Displacement:162cc



KPRS617009001

- 适用车型/Applicable Vehicle: 冷藏车/Refrigerated trucks
- 编号/Code:KPRS-KP16
- OE:/
- 皮带轮/Pulley:A2/135
- 电压/Voltage: 24V
- 排量/Displacement:162cc



KPRS617009003

- 适用车型/Applicable Vehicle: 冷藏车/Refrigerated trucks
- 编号/Code:KPRS-KP16
- OE:/
- 皮带轮/Pulley:A2/135
- 电压/Voltage: 12V
- 排量/Displacement:162cc



KPRS-617001017

- 适用车型/Applicable Vehicle: 冷藏车/Refrigerated trucks
- 编号/Code:KPRS-KP16
- OE:/
- 皮带轮/Pulley:B1/137
- 电压/Voltage: 12V
- 排量/Displacement:162cc



KPRS617001010

- 适用车型/Applicable Vehicle: 冷藏车/Refrigerated trucks
- 编号/Code:KPRS-KP16
- OE:/
- 皮带轮/Pulley:B1/137
- 电压/Voltage: 24V
- 排量/Displacement:162cc



KPRS617003006

- 适用车型/Applicable Vehicle: 冷藏车/Refrigerated trucks
- 编号/Code:KPRS-KP16
- OE:/
- 皮带轮/Pulley:A2/135
- 电压/Voltage: 12V
- 排量/Displacement:162cc

产品介绍

Product Introduction



在乎舒适、可靠、节能，就用康普瑞 & 康普瑞森压缩机

雷诺系列

选用型号

RENAULT SELECTION MODEL

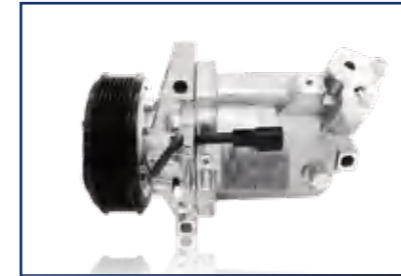

KPR-1277

- 适用车型/Applications: 雷诺风朗1.6L (7PK)
RENAULT MEGANE 3 2.0L
RENAULT FLUENCE 1.6 7PK
- OE: 926008367R/6284823042/
92600A092A/92600BV80A/
926003ZL1A/926005727R
- 皮带轮/Pulley: PV7/116
- 电压/Voltage: 12V



KPR-8384

- 适用车型/Applications: 达契亚-桑德罗2012
DACIA SANDERO/DUSTER
- OE: 92600-3541R/926005689R/
608212334
- 皮带轮/Pulley: PV7/99
- 电压/Voltage: 12V



KPR-8385

- 适用车型/Applications: 雷诺桑德罗 1.6/日产劲克
RENAULT SANDERO 2018 1.6
RENAULT CAPTUR 1.6 2019/JUKE
- OE: 926006053R/926001HC2D/
926005RB0A
- 皮带轮/Pulley: PV6/100
- 电压/Voltage: 12V



KPR-8395

- 适用车型/Applications: 雷诺
RENAULT CAPTUR
- OE: 926009158R/92600E460A
- 皮带轮/Pulley: PV7/108
- 电压/Voltage: 12V



KPR-8396

- 适用车型/Applications: 雷诺 LOGAN 1.0
RRNAULT LOGAN SANDRO
- OE: 926004984R/926005060R
- 皮带轮/Pulley: PV3/100
- 电压/Voltage: 12V



KPR-1124

- 适用车型/Applications: 达契亚 DOKKER 1.5DCI
DACIA DOKKER 1.5DCI
- OE: A42011A8402000/8201025121/
92600-3VC6B/926004634R/
926000105R/926001686R/
926009154R
- 皮带轮/Pulley: PV6/125
- 电压/Voltage: 12V



KPR-1255

- 适用车型/Applications: 雷诺风朗
RENAULT FLUENCE
- OE: A42011A8402000/8201025121/92600-
3VC6B/926004634R/926000105R/
926001686R/926009154R
- 皮带轮/Pulley: PV6/125
- 电压/Voltage: 12V



KPR-1262

- 适用车型/Applications: 雷诺风朗7PK
RENAULT CAPTUR 7PK
- OE: 926003859R
- 皮带轮/Pulley: PV7/112
- 电压/Voltage: 12V



KPR-1263

- 适用车型/Applications: 雷诺风朗1.6
RENAULT FLUENCE 1.6 6PK
FLUENCE 2.0 FLEX
- OE: 926009541R/92600A092C
- 皮带轮/Pulley: PV6/116
- 电压/Voltage: 12V



KPR-8375

- 适用车型/Applications:
达西亚 1.5 2017
DACIA SANDERO/DUSTER 1.5
2014-2018/RENAULT CLIO IV (5R)
- OE: 926005154R/926004475R
- 皮带轮/Pulley: PV6/100
- 电压/Voltage: 12V



KPR-1125

- 适用车型/Applications:
雷诺 洛根
RENAULT LOGAN
- OE: 926000216R
- 皮带轮/Pulley: PV7/115
- 电压/Voltage: 12V



KPRS612001003

- 适用车型/Applicable Vehicle:
雷诺19款Clio 1.0
2019 Clio 1.0
- 型号/Model: KPRS-6C12
- OE: 926009871R
- 皮带轮/Pulley: PV3/115
- 电压/Voltage: 12V
- 排量/Displacement: 125cc



KPRS613032032

- 适用车型/Applicable Vehicle:
雷诺梅甘娜1.5
Megane 1.5
- 型号/Model: KPRS-PXC14
- OE: 926006231R
- 皮带轮/Pulley: PV6/125
- 电压/Voltage: 12V
- 排量/Displacement: 133cc



KPRS612001001

- 适用车型/Applicable Vehicle:
雷诺21款Captur 1.0
Captur 1.0 2021/Renault Megane 4
- 型号/Model: KPRS-6C12
- OE: 926005450R
- 皮带轮/Pulley: PV7/115
- 电压/Voltage: 12V
- 排量/Displacement: 125cc



KPRS613055055

- 适用车型/Applicable Vehicle:
雷诺12-15款Clio1.2
Clio 1.2 2012-2015
- 型号/Model: KPRS-VCS14
- OE: 926000050R
- 皮带轮/Pulley: PV4/110
- 电压/Voltage: 12V
- 排量/Displacement: 133cc



KPRS614005005

- 适用车型/Applicable Vehicle:
达契亚12-13款Sandero1.2
DACIA SANDERO 1.2 2012-2023
- 型号/Model: KPRS-VCS14
- OE: 926000050R
- 皮带轮/Pulley: PV4/110
- 电压/Voltage: 12V
- 排量/Displacement: 133cc



KPRS613051047

- 适用车型/Applicable Vehicle:
雷诺 Clion V
Renault Clion V
- 型号/Model: KPRS-VCS14
- OE: 926004423R
- 皮带轮/Pulley: PV7/115
- 电压/Voltage: 12V
- 排量/Displacement: 133cc



KPRS612001002

- 适用车型/Applicable Vehicle:
雷诺20款Captur 1.3
2020 Captur 1.3
- 型号/Model: KPRS-6C12
- OE: 926002410R
- 皮带轮/Pulley: PV6/115
- 电压/Voltage: 12V
- 排量/Displacement: 125cc

产品介绍

Product Introduction



在乎舒适、可靠、节能，就用康普瑞 & 康普瑞森压缩机

斯巴鲁系列 选用型号

SUBARU SERIES SELECTION MODEL



KPR-6345

- 适用车型/Applications: 大发-MIRA COCOA 2012/斯巴鲁-斯特拉 12-14款 DAIHATSU/TANTO LA600S
- OE: 88310-B2280/447280-3213/88320-B2020/447160-4160
- 皮带轮/Pulley: PV3/120
- 电压/Voltage: 12V



KPR-8354

- 适用车型/Applications: 斯巴鲁翼豹 SUBARU IMPREZA WRX 2006
- OE: 73111FE030/A4201101A00003
- 皮带轮/Pulley: PV4/125
- 电压/Voltage: 12V



KPR-8365

- 适用车型/Applications: 斯巴鲁 斯特拉/R2 SUBARU STELLA/R2
- OE: 73111KG010/A42011A2501001
- 皮带轮/Pulley: PV4/104
- 电压/Voltage: 12V



KPR-96188

- 适用车型/Applications: 斯巴鲁森林人 (S11) SUBARU FORESTER S11
- OE: /
- 皮带轮/Pulley: PV6/124
- 电压/Voltage: 12V



KPR-1102

- 适用车型/Applications: 斯巴鲁XV 6PK SUBARU IMPREZA XV 1.6B-2.0B '13->... SUBARU IMPREZA XV 2.5L '12->'13 (6PK)
- OE: 73111FJ000/Z0014247A/Z0014247B/73111FJ010/Z0014248B/73111FJ040/Z0014247B/Z0021226A/DKV-10Z/Z001424713
- 皮带轮/Pulley: PV6/110
- 电压/Voltage: 12V



KPR-1103

- 适用车型/Applications: 斯巴鲁XV 7PK SUBARU IMPREZA XV 2.5L '12->'13 (7PK)
- OE: /
- 皮带轮/Pulley: PV7/110
- 电压/Voltage: 12V



KPR-1104

- 适用车型/Applications: 斯巴鲁森林人S11 SUBARU IMPREZA III '08
- OE: 73111FG000/506021-7562/73111FG001/Z0007584A/Z0007584B/73111FG002/Z0011100A
- 皮带轮/Pulley: PV4/96
- 电压/Voltage: 12V



KPR-1105

- 适用车型/Applications: 斯巴鲁森林人S12 SUBARU FORESTER 2.5L '11->'12 SUBARU IMPREZA 2.5L '11->'12
- OE: 73111SC020/Z0012269A
- 皮带轮/Pulley: PV6/110
- 电压/Voltage: 12V



KPR-1106

- 适用车型/Applications: 斯巴鲁力狮B14 SUBARU LEGACY 2.5L '05->'06
- OE: 447260-7940/73111-AG000/88320-B1010/88320B1010/10361570
- 皮带轮/Pulley: PV4/92
- 电压/Voltage: 12V



KPR-1108

- 适用车型/Applications:
斯巴鲁新款力狮
SUBARU IMPREZA BRZ 2.0L
2013-2015/SCION FR-S 2.0L
2014/TOYOTA GT86
- OE: 447280-3260/73111CA001
- 皮带轮/Pulley: PV6/100
- 电压/Voltage: 12V



KPR-1136

- 适用车型/Applications:
斯巴鲁翼豹 2.0L
SUBARU IMPREZA 2.0L(2017-2019)
- OE: 447280-3580
- 皮带轮/Pulley: PV6/100
- 电压/Voltage: 12V



KPR-1426

- 适用车型/Applications:
斯巴鲁翼豹 (00-08) /黑金刚
SUBARU IMPREZA
- OE: 73111FA100/73111FE000
- 皮带轮/Pulley: PV4/φ124
- 电压/Voltage: 12V



KPR-1137

- 适用车型/Applications:
斯巴鲁 力狮 6PK
SUBARU LEGACY 6PK
- OE: /
- 皮带轮/Pulley: PV6/93
- 电压/Voltage: 12V



KPR-1111

- 适用车型/Applications:
斯巴鲁翼豹 1.6L
SUBARU IMPREZA 1.6 2017-
- OE: 73111-FL050
- 皮带轮/Pulley: PV6/110
- 电压/Voltage: 12V



KPR-6314

- 适用车型/Applications:
斯巴鲁
SUBARU SAMBAR LE-TV2
- OE: 506021-7120/73111TC030
- 皮带轮/Pulley: PV4/104
- 电压/Voltage: 12V



KPR-96217

- 适用车型/Applications:
03款 森林人 2.0
FORESTER 2.0 2003
- OE: /
- 皮带轮/Pulley: PV4/124
- 电压/Voltage: 12V



KPRS613014012

- 适用车型/Applicable Vehicle:
傲虎3.6
Outback 3.6
- 型号/Model: KPRS-6SE13
- OE: 73111-AJ00A
- 皮带轮/Pulley: PV6/110
- 电压/Voltage: 12V
- 排量/Displacement: 133cc



KPRS613015012

- 适用车型/Applicable Vehicle:
力狮2.5 /3.6
Legacy 2.5 /3.6
- 型号/Model: KPRS-6SE13
- OE: 73111AJ03A/73111AL00A
- 皮带轮/Pulley: PV6/110
- 电压/Voltage: 12V
- 排量/Displacement: 133cc

产品介绍

Product Introduction



铃木系列 选用型号

SUZUKI SERIES SELECTION MODEL

在乎舒适、可靠、节能，就用康普瑞 & 康普瑞森压缩机

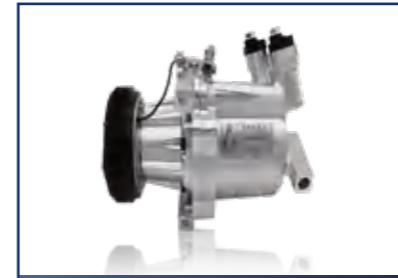

KPR-8382

- 适用车型/Applications: 铃木派喜2008-/欧宝08-14 SUZUKI SPLASH 2008-/OPEL 2008-2014
- OE: 9520051KA0/Z0006291A 9870162679
- 皮带轮/Pulley: PV4/100
- 电压/Voltage: 12V



KPR-8388

- 适用车型/Applications: 铃木雨燕3代/SX4 2006-SUZUKI SWIFT /SX4 SUV 2006-
- OE: 9520062JA0/AKC200A083A AKC201A083A/MS60CAS
- 皮带轮/Pulley: PV4/90.6
- 电压/Voltage: 12V



KPR-8399

- 适用车型/Applications: 铃木 维特拉 SX4 SUZUKI GRAND VITARA SX4
- OE: 95200-61M02/AKV200A411A
- 皮带轮/Pulley: PV4/95
- 电压/Voltage: 12V



KPR-96167

- 适用车型/Applications: 铃木 SUZUKI GRAND VITARA 1.6(90-98)
- OE: 9520170CH0
- 皮带轮/Pulley: PV4/110
- 电压/Voltage: 12V



KPR-83129

- 适用车型/Applications: 铃木 JUSTY LLL 2003-2007 1.3 SUZUKI IGNIS
- OE: 95200-86GA0/AKC200A081
- 皮带轮/Pulley: PV4/90.6
- 电压/Voltage: 12V



KPR-1122

- 适用车型/Applications: 铃木启悦 SUZUKI ALIVIO
- OE: /
- 皮带轮/Pulley: PV4/110
- 电压/Voltage: 12V



KPR-9604

- 适用车型/Applications: 羚羊/奔奔/悦翔 SUZUKI GRAND VITARA 1.6 (90-98)/2.0 (94-98)/2.5 (98-03)
- OE: 9520170CH0/51-0362 95201-70CH0/W04K086492
- 皮带轮/Pulley: PV4/110
- 电压/Voltage: 12V



KPR-9648

- 适用车型/Applications: 铃木超级维特拉 SUZUKI GRAND VITARA
- OE: /
- 皮带轮/Pulley: PV5/110
- 电压/Voltage: 12V



KPR-9629

- 适用车型/Applications: 奥拓 SUZUKI ALTO
- OE: /
- 皮带轮/Pulley: 单O槽/118
- 电压/Voltage: 12V



KPR-6342

- 适用车型/Applications: 铃木 吉姆尼 SUZUKI JIMNY
- OE: /
- 皮带轮/Pulley: PV4/110
- 电压/Voltage: 12V



KPR-8342

- 适用车型/Applications: 铃木雨燕 V (AZ) 1.2 SUZUKI SWIFT V (AZ)1.2 (A2L412)
- OE: 4472803582/9520152RA0
- 皮带轮/Pulley: PV4/110
- 电压/Voltage: 12V



KPR-8304

- 适用车型/Applications: 昌河铃木北斗星 CHANGHE SUZUKI WAGON R
- OE: /
- 皮带轮/Pulley: PV4/100
- 电压/Voltage: 12V



KPR-6315

- 适用车型/Applications: SUZUKI WAGON R 2005
- OE: 95201-58J00/95200-58J10/95200-58J11/95200-58J01/95200-58JA1/95201-58J10/1A21-61-450/1A17-61-450/27630-4A00B/27630-4A00D
- 皮带轮/Pulley: PV4/93
- 电压/Voltage: 12V



KPR-6317

- 适用车型/Applications: 铃木吉姆尼 SUZUKI JIMNY JIMNY SEIKO SEIKI
- OE: 95200-77GB2/95201-77GB2/9520060 B51/2906175428/W08K0821064/W04K056332/SS07LK10
- 皮带轮/Pulley: PV4/110
- 电压/Voltage: 12V



KPR-6320

- 适用车型/Applications: 铃木 WAGON SUZUKI WAGON
- OE: 95200-58J40/95201-58J40/95200-58J41/95201-58JT41/27630-4A01B/27630-4A00H/27630-4A00H
- 皮带轮/Pulley: PV4/93
- 电压/Voltage: 12V



KPR-83149

- 适用车型/Applications: 铃木 SWIFT SUZUKI SWIFT
- OE: /
- 皮带轮/Pulley: PV6/109
- 电压/Voltage: 12V



KPR-8322

- 适用车型/Applications: 铃木 SUZUKI SWIFT 2019
- OE: 95201-52R00/447280-3572
- 皮带轮/Pulley: PV4/110
- 电压/Voltage: 12V



KPR-8344

- 适用车型/Applications: 铃木雨燕1.2 SUZUKI SWIFT 2011, 2012 SUZUKI WAGON R SOLIO
- OE: 95200-68LA0/95200-68LA1/95200-68LA3/95200-68LB0
- 皮带轮/Pulley: PV5/114
- 电压/Voltage: 12V



KPR-6331

- 适用车型/Applications: 铃木 WAGON SUZUKI WAGON
- OE: 95201-50M00
- 皮带轮/Pulley: PV5/114
- 电压/Voltage: 12V



KPR-6333

- 适用车型/Applications: 铃木 WAGON 6PK SUZUKI WAGON 6PK
- OE: 95200-50M30/95201-50M30
- 皮带轮/Pulley: PV6/114
- 电压/Voltage: 12V



KPR-6335

- 适用车型/Applications: 铃木奥拓 SUZUKI ALTO 2017
- OE: 95200-74P10/95201-74P10 447280-3410
- 皮带轮/Pulley: PV6/114
- 电压/Voltage: 12V



KPR-96189

- 适用车型/Applications: 铃木 ERTIGA 2012款 SUZUKI CIAZ SUZUKI ERTIGA 2012-
- OE: CRMS007EC/D22C041074
- 皮带轮/Pulley: PV6/100
- 电压/Voltage: 12V



KPR-9614

- 适用车型/Applications: 昌河铃木北斗星 CHANGHE SUZUKI WAGON R
- OE: /
- 皮带轮/Pulley: PV4/100
- 电压/Voltage: 12V



KPR-9615

- 适用车型/Applications: 昌河铃木北斗星 CHANGHE SUZUKI WAGON R
- OE: /
- 皮带轮/Pulley: PV4/100
- 电压/Voltage: 12V



KPR-6352

- 适用车型/Applications: 铃木速翼特 SUZUKI SWIFT SPORT FZ NZ IV 1.6/SUZUKI SWIFT 1.6 SPORT
- OE: 95200-68LB0/AKS200A207
- 皮带轮/Pulley: PV4/95
- 电压/Voltage: 12V



KPR-6363

- 适用车型/Applications: 铃木-HUSTLER SUZUKI-HUSTLER
- OE: 95201-65R00/95200-59S00 95200-59S20/95200-59SC0
- 皮带轮/Pulley: PV4/93
- 电压/Voltage: 12V



KPR-8302

- 适用车型/Applications: 铃木雨燕/天语 SUZUKI SWIFT/SX4
- OE: 95201-69GCO/95200-77JAO 9520077JAO/9520169GCO
- 皮带轮/Pulley: PV4/110
- 电压/Voltage: 12V



KPR-8303

- 适用车型/Applications: 新奥拓 SUZUKI SWIFT
- OE: 95200-83KA0/T090501761 95200-83KB0
- 皮带轮/Pulley: PV4/110
- 电压/Voltage: 12V



KPR-8343

- 适用车型/Applications: 铃木IGNIS 1.2 (2017) SUZUKI IGNIS 1.2 (2017)
- OE: 95201-62R00/95210-62R20 95201-66R00/95201-62R11
- 皮带轮/Pulley: PV4/100
- 电压/Voltage: 12V



KPR-96190

- 适用车型/Applications: 铃木 CIAZ SUZUKI CIAZ 1.4
- OE: 14-1360/95200M83KB0/95200M83KC 1/95201-79M00/9520179M00 /9520179M00/D16G07109318
- 皮带轮/Pulley: PV4/100
- 电压/Voltage: 12V



KPR-96101

- 适用车型/Applications: 铃木启悦/锋驭/维特拉 SUZUKI VITARA 2015-2016 SUZUKI ALIVIO
- OE: 95201-66M00
- 皮带轮/Pulley: PV4/110
- 电压/Voltage: 12V



KPR-96108

- 适用车型/Applications: 铃木吉姆尼 1.5 SUZUKI JIMNY 1.5
- OE: 95201-70CN2/95201-70CN0 9520170CN2/9520170CN0
- 皮带轮/Pulley: PV6/118
- 电压/Voltage: 12V



KPR-96171

- 适用车型/Applications: 铃木SUZUKI / SS10L DYS-COMP GRAND VITARA XL5
- OE: /
- 皮带轮/Pulley: PV5/110
- 电压/Voltage: 12V



KPR-8348

- 适用车型/Applications: 铃木SX4 SUZUKI SX4
- OE: 9520054LA0/9520154LA0 60-03605NC
- 皮带轮/Pulley: PV6/110
- 电压/Voltage: 12V



KPR-8367

- 适用车型/Applications: 铃木SX-4/雨燕 SUZUKI SX-4/SWIFT
- OE: 9520063JA0/9520063 JA1/9520163JA0
- 皮带轮/Pulley: PV4/110
- 电压/Voltage: 12V



KPR-8369

- 适用车型/Applications: 铃木雨燕 SUZUKI SWIFT 2017
- OE: 95201-52R10/447280-3593
- 皮带轮/Pulley: PV4/110
- 电压/Voltage: 12V



KPR-83160

- 适用车型/Applications: 20款 雨燕 1.2 SWIFT BALENO
- OE: 95201-80S00
- 皮带轮/Pulley: PV7/115
- 电压/Voltage: 12V



KPR-83161

- 适用车型/Applications: 铃木伊尼斯III 1.2 混合动力版 (15款) SUZUKI IGNIS I11 1.2 HYBRID (15-)
- OE: 95201-73S10
- 皮带轮/Pulley: PV7/115
- 电压/Voltage: 12V



KPR-8370

- 适用车型/Applications: 铃木利亚纳 SUZUKI LIANA
- OE: /
- 皮带轮/Pulley: PV4/110
- 电压/Voltage: 12V



KPR-8372

- 适用车型/Applications: 铃木雨燕/雨燕 5PK SUZUKI SWIFT/SWIFT 5PK
- OE: 9520080JA0/9520080JA1 95200-80JA2/9520180JA0
- 皮带轮/Pulley: PV5/110
- 电压/Voltage: 12V



KPR-8374

- 适用车型/Applications: 铃木 CELERIO 1.0 2015 SUZUKI CELERIO
- OE: 95200-84M00/9520084M41
- 皮带轮/Pulley: PV4/110
- 电压/Voltage: 12V

产品介绍

Product Introduction



在乎舒适、可靠、节能，就用康普瑞 & 康普瑞森压缩机

丰田系列 选用型号

TOYOTA SERIES SELECTION MODEL

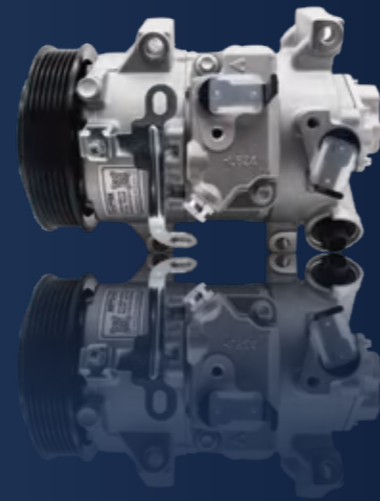

KPRS613009015

- 适用车型/Applicable Vehicle: 2014款 卡罗拉/Corolla 2014
- 型号/Model:KPRS-6SE13
- OE:8831002A81
- 皮带轮/Pulley:PV6/120
- 电压/Voltage:12V
- 排量/Displacement:133cc



KPRS613009016

- 适用车型/Applicable Vehicle: 卡罗拉 (7PK) RAV4 ALA49R '2/13-2/19 SUITS ALA49R 2.2L Corolla (7PK) Toyota RAV4 2.0 2.2 2013-
- 型号/Model:KPRS-6SE13
- OE:88310-42370
- 皮带轮/Pulley:PV7/120
- 电压/Voltage:12V
- 排量/Displacement:133cc



KPRS613010010

- 适用车型/Applicable Vehicle: 2008款 卡罗拉/Corolla 2008
- 型号/Model:KPRS-6SE13
- OE:88310-02500
- 皮带轮/Pulley:PV6/120
- 电压/Voltage:12V
- 排量/Displacement:133cc



KPRS613010011

- 适用车型/Applicable Vehicle: 卡罗拉 (7PK) /Corolla (7PK)
- 型号/Model:KPRS-6SE13
- OE:4472807931
- 皮带轮/Pulley:PV7/110
- 电压/Voltage:12V
- 排量/Displacement:133cc



KPRS613011015

- 适用车型/Applicable Vehicle: 丰田逸致 2012款 卡罗拉 TOYOTA VERSO COROLLA 2012
- 型号/Model:KPRS-6SE13
- OE:8831002711
- 皮带轮/Pulley:PV6/120
- 电压/Voltage:12V
- 排量/Displacement:133cc



KPRS613033033

- 适用车型/Applicable Vehicle: 丰田AVENSIS 1.6 TOYOTA avensis 1.6
- 型号/Model:KPRS-6SE13
- OE:88310-0F070
- 皮带轮/Pulley:PV5/113
- 电压/Voltage:12V
- 排量/Displacement:133cc



KPRS613034012

- 适用车型/Applicable Vehicle: 广汽丰田雷凌1.2T Toyota Levin 1.2T
- 型号/Model:KPRS-6SE13
- OE:8831002B40
- 皮带轮/Pulley:PV6/110
- 电压/Voltage:12V
- 排量/Displacement:133cc



KPRS613034015

- 适用车型/Applicable Vehicle: 丰田奕泽/丰田CHR (国外) TOYOTA Isawa /TOYOTA CHR
- 型号/Model:KPRS-6SE13
- OE:88310-02790
- 皮带轮/Pulley:PV6/120
- 电压/Voltage:12V
- 排量/Displacement:133cc



KPRS613037010

- 适用车型/Applicable Vehicle: RAV4 III/RAV4 III
- 型号/Model:KPRS-6SE13
- OE:88310-42310
- 皮带轮/Pulley:PV6/120
- 电压/Voltage:12V
- 排量/Displacement:133cc



KPRS616001001

- 适用车型/Applicable Vehicle: 2008款 凯美瑞/Camry 2008
- 型号/Model:KPRS-6SE16
- OE:88310-06330
- 皮带轮/Pulley:PV7/110
- 电压/Voltage:12V
- 排量/Displacement:160cc



KPRS616009001

- 适用车型/Applicable Vehicle: 海狮/Toyota HIACE
- 型号/Model:KPRS-6SE16
- OE:88310-2F030
- 皮带轮/Pulley:PV7/110
- 电压/Voltage:12V
- 排量/Displacement:160cc



KPRS616010017

- 适用车型/Applicable Vehicle: 皇冠2.5、锐志/雷克萨斯GS300(国外版) CROWN 2.5、REIZ/LEXUS GS300
- 型号/Model:KPRS-6SE16
- OE:88320-3A270
- 皮带轮/Pulley:PV7/115
- 电压/Voltage:12V
- 排量/Displacement:160cc



KPRS616017017

- 适用车型/Applicable Vehicle: 皇冠3.0/Crown3.0
- 型号/Model:KPRS-6SE16
- OE:88320-33200
- 皮带轮/Pulley:PV7/115
- 电压/Voltage:12V
- 排量/Displacement:160cc



KPRS616017028

- 适用车型/Applicable Vehicle: 2009款 凯美瑞 (国外) Camry 2009
- 型号/Model:KPRS-6SE16
- OE:8832033200
- 皮带轮/Pulley:PV7/110
- 电压/Voltage:12V
- 排量/Displacement:160cc



KPRS616031031

- 适用车型/Applicable Vehicle: 2011款丰田凌放 Toyota Harrier 2011
- 型号/Model:KPRS-6SE16
- OE:447260-3390
- 皮带轮/Pulley:PV7/130
- 电压/Voltage:12V
- 排量/Displacement:160cc



KPRS717008015

- 适用车型/Applicable Vehicle: 2012款 凯美瑞2.5 Camry 2.5L 2012
- 型号/Model:KPRS-7SE17
- OE:8831006460
- 皮带轮/Pulley:PV6/120
- 电压/Voltage:12V
- 排量/Displacement:170.5cc



KPRS717008016

- 适用车型/Applicable Vehicle: 2012款 凯美瑞2.0L Camry 2.0L 2012
- 型号/Model:KPRS-7SE17
- OE:8831006470
- 皮带轮/Pulley:PV7/120
- 电压/Voltage:12V
- 排量/Displacement:170.5cc



KPRS717009012

- 适用车型/Applicable Vehicle: 2013款 RAV4 2.0 RAV4 2.0 2013
- 型号/Model:KPRS-7SE17
- OE:88310-33320
- 皮带轮/Pulley:PV6/110
- 电压/Voltage: 12V
- 排量/Displacement:170.5cc



KPRS717009015

- 适用车型/Applicable Vehicle: 2014款 凯美瑞2.5/2014款 RAV4 2.5/2015款 RAV4荣放2.0 2014 Camry2.5/2014 RAV4 2.5 2015 RAV4 2.0
- 型号/Model:KPRS-7SE17
- OE:88310-0E150
- 皮带轮/Pulley:PV6/120
- 电压/Voltage:12V
- 排量/Displacement:170.5cc



KPRS717010015

- 适用车型/Applicable Vehicle: 2014款 凯美瑞 2.0/2014款 RAV4 2.0/2015款 RAV4荣放2.5 2014 Camry 2.0/2014 RAV4 2.0 2015 RAV4 2.5
- 型号/Model:KPRS-7SE17
- OE:88310-0R070
- 皮带轮/Pulley:PV6/120
- 电压/Voltage:12V
- 排量/Displacement:170.5cc



KPRS717011017

- 适用车型/Applicable Vehicle: 2015款皇冠 2014款 雷克萨斯IS250 2.5 2015 Crown/Lexus IS250 2.5 2014
- 型号/Model:KPRS-7SE17
- OE:447280-7561
- 皮带轮/Pulley:PV7/115
- 电压/Voltage:12V
- 排量/Displacement:170.5cc



KPRS717011032

- 适用车型/Applicable Vehicle: 2013款 皇冠/雷克萨斯 2016-2018款 汉兰达 (国外) Crown/Lexus 2013 Highlander 2016-2018
- 型号/Model:KPRS-7SE17
- OE:447280-8734
- 皮带轮/Pulley:PV6/115
- 电压/Voltage:12V
- 排量/Displacement:170.5cc



KPRS717012017

- 适用车型/Applicable Vehicle: 2017款 塞纳 2016-2018凌志RX350 Senna 2017 Lexus RX350 2016-2018
- 型号/Model:KPRS-7SE17
- OE:883203A520
- 皮带轮/Pulley:PV7/115
- 电压/Voltage:12V
- 排量/Displacement:170.5cc



KPRS717012018

- 适用车型/Applicable Vehicle: 2015款 锐志/2013款 RAV4 REIZ 2015/RAV4 2013
- 型号/Model:KPRS-7SE17
- OE:883203A510
- 皮带轮/Pulley:PV6/120
- 电压/Voltage:12V
- 排量/Displacement:170.5cc



KPRS717028028

- 适用车型/Applicable Vehicle: 凌志ES350/Lexus ES350
- 型号/Model:KPRS-7SE17
- OE:8832028420
- 皮带轮/Pulley:PV7/110
- 电压/Voltage:12V
- 排量/Displacement:170.5cc



KPRS717029028

- 适用车型/Applicable Vehicle: 汉兰达3.5/Highlander 3.5
- 型号/Model:KPRS-7SE17
- OE:8832048150
- 皮带轮/Pulley:PV7/110
- 电压/Voltage:12V
- 排量/Displacement:170.5cc



KPRS717030030

- 适用车型/Applicable Vehicle: 汉兰达2.7/Highlander 2.7
- 型号/Model:KPRS-7SE17
- OE:88310-0E050
- 皮带轮/Pulley:PV6/110
- 电压/Voltage:12V
- 排量/Displacement:170.5cc



KPR-6330

- 适用车型/Applications:
丰田帕索
TOYOTA PASSO/PERODUA MYVI 1.3
DAIHATSU SIRION 1.3L (4PK)
- OE: 88310B1070/447190-6620/CP490001/
8832097401/447260-5550/447260-5054/
447260-5820/447190-6625/447190-6620/
DCP490001
- 皮带轮/Pulley: PV4/92.5
- 电压/Voltage: 12V



KPR-6332

- 适用车型/Applications:
丰田帕索6PK
TOYOTA RUSH 2006
TOYOTA TERIOS 2004
DAIHATSU TERIOS 2007-2012 (6PK,105)
- OE: 447160-2270/447190-6121/88310-84060/
447260-5820/88310-B1010/88310-84060
- 皮带轮/Pulley: PV6/107
- 电压/Voltage: 12V



KPRS509002005

- 适用车型/Applicable Vehicle:
雅力士
YARIS 2006 1.3L/YARIS 2005-2010
- 型号/Model: KPRS-5SE09
- OE: 88310-52550
- 皮带轮/Pulley: PV4/120
- 电压/Voltage: 12V
- 排量/Displacement: 89cc



KPR-6338

- 适用车型/Applications:
大发
DAIHATSU HIJET
- OE: 88310-B5090/88320B5030/
88320B5060
- 皮带轮/Pulley: PV3/120
- 电压/Voltage: 12V



KPR-6346

- 适用车型/Applications:
丰田帕杰罗
DAIHATSU SIRION 05
- OE: 88310BZ160/DCP49001
88320B4010
- 皮带轮/Pulley: PV4/92.5
- 电压/Voltage: 12V



KPR-6357

- 适用车型/Applications:
丰田帕索6PK
TOYOTA PASSO 6PK
- OE: /
- 皮带轮/Pulley: PV6/92.5
- 电压/Voltage: 12V



KPR-83117

- 适用车型/Applications:
丰田卡罗拉
COROLLA01-04
- OE: 8831002180/8831002320
NISSENS 890036
- 皮带轮/Pulley: PV6/93
- 电压/Voltage: 12V



KPR-8347

- 适用车型/Applications:
丰田卡罗拉
TOYOTA COROLLA E12 2.0
- OE: 447260-7100/88310-13032/88310-
13031/447260-7090/447180-9110/
883101A580/447180-9220
- 皮带轮/Pulley: PV6/100
- 电压/Voltage: 12V



KPR-8390

- 适用车型/Applications:
丰田特锐 单O/DAIHATSU TERIOS
DAIHATSU TERIOS YRV 1.3
- OE: 4472206900/4472009880/4472009881/
4472009882/4472009883/4472009884/
4472009885/4472009886/447220-6900
- 皮带轮/Pulley: 单O槽/110
- 电压/Voltage: 12V



KPRS717041017

- 适用车型/Applicable Vehicle:
凯美瑞2013 3.5L/雷克萨斯ES350、RX350
Camry 2013 3.5L/ Lexus ES350、RX350
- 型号/Model: KPRS-7SE17
- OE: 88320-33210
- 皮带轮/Pulley: PV7/115
- 电压/Voltage: 12V
- 排量/Displacement: 170.5cc



KPRS717041018

- 适用车型/Applicable Vehicle:
2015款 凯美瑞/Camry 2015
- 型号/Model: KPRS-7SE17
- OE: 8831006400
- 皮带轮/Pulley: PV6/120
- 电压/Voltage: 12V
- 排量/Displacement: 170.5cc



KPRS717045030

- 适用车型/Applicable Vehicle:
雷克萨斯 LS460/Lexus LS460
- 型号/Model: KPRS-7SE17
- OE: 8831050160
- 皮带轮/Pulley: PV6/110
- 电压/Voltage: 12V
- 排量/Displacement: 170.5cc



KPRS717066017

- 适用车型/Applicable Vehicle:
雷克萨斯7PK (国外)
Toyota Highlander Sienna
Lexus RX350 3.5L 2010-2015
- 型号/Model: KPRS-7SE17
- OE: 88320-48220
- 皮带轮/Pulley: PV7/115
- 电压/Voltage: 12V
- 排量/Displacement: 170.5cc



KPRS616035010

- 适用车型/Applicable Vehicle:
2008款 凯美瑞/Camry 2008
- 型号/Model: KPRS-6SE16
- OE: 88310-06330
- 皮带轮/Pulley: PV6/120
- 电压/Voltage: 12V
- 排量/Displacement: 160cc



KPRS509002002

- 适用车型/Applicable Vehicle:
08款 威驰1.3/08款 雅力士1.3
2008VIOS 1.3/2008 YARIS 1.3
- 型号/Model: KPRS-5SE09
- OE: 8831052250
- 皮带轮/Pulley: PV4/110
- 电压/Voltage: 12V
- 排量/Displacement: 89cc



KPRS509002003

- 适用车型/Applicable Vehicle:
06-11款 雅力士1.3
YARIS 1.3 2006-2011
- 型号/Model: KPRS-5SE09
- OE: 88310-0D202/88310-0D320
- 皮带轮/Pulley: PV6/100
- 电压/Voltage: 12V
- 排量/Displacement: 89cc



KPRS509002004

- 适用车型/Applicable Vehicle:
99-05款 雅力士1.0
YARIS 1.0 1999-2005
- 型号/Model: KPRS-5SE09
- OE: 88310-0D202
88310-0D320
- 皮带轮/Pulley: PV6/110
- 电压/Voltage: 12V
- 排量/Displacement: 89cc



KPRS512002002

- 适用车型/Applicable Vehicle:
标致6
丰田CHR 1.2 2.0 2016-2019
PEUGEOT 6
TOYOTA CHR 1.2 2.0 2016-2019
- 型号/Model: KPRS-5SL12
- OE: 64526915380
- 皮带轮/Pulley: PV6/110
- 电压/Voltage: 12V
- 排量/Displacement: 123cc



KPR-8391

- 适用车型/Applications:
丰田特锐 4PK
DAIHATSU TERIOS
DAIHATSU TERIOS YRV 1.3
- OE: 447200-9887
- 皮带轮/Pulley: PV4/105
- 电压/Voltage: 12V



KPR-8397

- 适用车型/Applications:
丰田雅力士
TOYOTA YARIS
- OE: 88310-52351
- 皮带轮/Pulley: PV4/110
- 电压/Voltage: 12V



KPR-63104

- 适用车型/Applications:
大发
DAIHATSU
- OE: /
- 皮带轮/Pulley: PV4/120
- 电压/Voltage: 12V



KPR-7217

- 适用车型/Applications:
大发
DAIHATSU
- OE: 88310-B5140
- 皮带轮/Pulley: PV3/100
- 电压/Voltage: 12V



KPR-6322

- 适用车型/Applications:
丰田
TOYOTA
- OE: /
- 皮带轮/Pulley: PV4/93
- 电压/Voltage: 12V



KPR-6348

- 适用车型/Applications:
大发
DAIHATSU
- OE: /
- 皮带轮/Pulley: A1/120
- 电压/Voltage: 12V



KPR-6361

- 适用车型/Applications:
大发
DAIHATSU
- OE: /
- 皮带轮/Pulley: A1/120
- 电压/Voltage: 12V



KPR-6365

- 适用车型/Applications:
大发
DAIHATSU MIRAVAN L 275
2007-2009
- OE: 88310-B2180
- 皮带轮/Pulley: PV6/92
- 电压/Voltage: 12V



KPR-6371

- 适用车型/Applications:
大发
DAIHATSU MOVE
- OE: 88310-B2210/47190-7522
- 皮带轮/Pulley: 单O槽/123
- 电压/Voltage: 12V



KPR-7206

- 适用车型/Applications:
丰田
TOYOTA RUMIONG S 4WD G5
TOYOTA PASSO
- OE: 447140-1700/447280-3830
447280-3600
- 皮带轮/Pulley: PV6/105
- 电压/Voltage: 12V

产品介绍

Product Introduction



双向活塞系列

选用型号

TWO WAY SERIES SELECTION MODELS



在乎舒适、可靠、节能，就用康普瑞 & 康普瑞森压缩机



KPRS111002010

- 适用车型/Applicable Vehicle: 凯普特(柳机)/东风凯马途逸 1.8L
- 编号/Code: KPRS-10S11
- OE: /
- 皮带轮/Pulley: PV6/110
- 电压/Voltage: 12V
- 排量/Displacement: 116cc



KPRS111002001

- 适用车型/Applicable Vehicle: 东风小霸王/凯马5PK
- 编号/Code: KPRS-10S11
- OE: /
- 皮带轮/Pulley: PV5/122
- 电压/Voltage: 12V
- 排量/Displacement: 116cc



KPRS121501501

- 适用车型/Applicable Vehicle: 图雅诺
- 型号/Model: KPRS-KD21
- OE: /
- 皮带轮/Pulley: PV4/110
- 电压/Voltage: 12V
- 排量/Displacement: 215cc



KPRS121501502

- 适用车型/Applicable Vehicle: 图雅诺6PK
- 编号/Code: KPRS-KD21
- OE: /
- 皮带轮/Pulley: PV6/119
- 电压/Voltage: 24V
- 排量/Displacement: 215cc



KPRS121501503

- 适用车型/Applicable Vehicle: 福田MPV 2A
- 编号/Code: KPRS-KD21
- OE: /
- 皮带轮/Pulley: A2/125
- 电压/Voltage: 12V
- 排量/Displacement: 215cc



KPRS117001001

- 适用车型/Applicable Vehicle: 福迪SUV
- 编号/Code: KPRS-10PA17
- OE: /
- 皮带轮/Pulley: PV4/120
- 电压/Voltage: 12V
- 排量/Displacement: 170.8cc



KPRS113015015

- 适用车型/Applicable Vehicle: 东安N20发动机
风光580 1.8L
- 型号/Model: KPRS-10S13
- OE: /
- 皮带轮/Pulley: PV6/110
- 电压/Voltage: 12V
- 排量/Displacement: 138cc



KPRS113026026

- 适用车型/Applicable Vehicle: 北汽212 T01
江铃新宝典
- 型号/Model: KPRS-10S13
- OE: /
- 皮带轮/Pulley: PV6/110
- 电压/Voltage: 12V
- 排量/Displacement: 138cc



KPRS113002002

- 适用车型/Applicable Vehicle: 东风多利卡T17、江淮骏铃V5
- 编号/Code: KPRS-10S13A
- OE: /
- 皮带轮/Pulley: PV6/110
- 电压/Voltage: 12V
- 排量/Displacement: 129cc



KPRS113018018

- 适用车型/Applicable Vehicle: 上汽大通
- 编号/Code:KPRS-10S13
- OE:/
- 皮带轮/Pulley:PV7/119
- 电压/Voltage:24V
- 排量/Displacement:138cc



KPRS113025025

- 适用车型/Applicable Vehicle: 伊朗赛帕: SP100 SHAHIN PLUS
- 编号/Code:KPRS-10S13A
- OE:/
- 皮带轮/Pulley:PV4/108
- 电压/Voltage:12V
- 排量/Displacement:138cc



KPRS113028028

- 适用车型/Applicable Vehicle: 云内DEF47发动机
江淮轻卡8KP 24V
- 编号/Code:KPRS-10S13
- OE:/
- 皮带轮/Pulley:PV8/128
- 电压/Voltage:24V
- 排量/Displacement:138cc



KPRS113003003

- 适用车型/Applicable Vehicle: 云内D20发动机、江淮轻卡6PK 24V
- 编号/Code:KPRS-10S13
- OE:/
- 皮带轮/Pulley:PV6/128
- 电压/Voltage:24V
- 排量/Displacement:138cc



KPRS113003004

- 适用车型/Applicable Vehicle: 福田欧马可
- 编号/Code:KPRS-10S13
- OE:/
- 皮带轮/Pulley:PV6/128
- 电压/Voltage:12V
- 排量/Displacement:138cc



KPRS113033033

- 适用车型/Applicable Vehicle: 三菱扶桑
- 编号/Code:KPRS-10S13
- OE:/
- 皮带轮/Pulley:A1/133
- 电压/Voltage:24V
- 排量/Displacement:138cc



KPRS113032032

- 适用车型/Applicable Vehicle: 重庆哈佛
- 编号/Code:KPRS-10S13
- OE:/
- 皮带轮/Pulley:2A/126
- 电压/Voltage:24V
- 排量/Displacement:138cc



KPRS113003022

- 适用车型/Applicable Vehicle: 云内D20发动机、江淮轻卡7PK 24V
- 型号/Model:KPRS-10S13
- OE:/
- 皮带轮/Pulley:PV7/128
- 电压/Voltage:24V
- 排量/Displacement:138cc



KPRS113010010

- 适用车型/Applicable Vehicle: 吉林一汽T80
- 型号/Model:KPRS-10S13A
- OE:/
- 皮带轮/Pulley:PV5/110
- 电压/Voltage:12V
- 排量/Displacement:127cc



KPRS113003009

- 适用车型/Applicable Vehicle: 云内D20发动机、福田欧马可
- 编号/Code:KPRS-10S13
- OE:/
- 皮带轮/Pulley:PV6/128
- 电压/Voltage:12V
- 排量/Displacement:138cc



KPRS113004003

- 适用车型/Applicable Vehicle: 云内D20发动机、江淮轻卡6PK 24V
- 编号/Code:KPRS-10S13
- OE:/
- 皮带轮/Pulley:PV6/128
- 电压/Voltage:24V
- 排量/Displacement:138cc



KPRS113005005

- 适用车型/Applicable Vehicle: 福田揽福皮卡
- 编号/Code:KPRS-10S13
- OE:/
- 皮带轮/Pulley:PV4/120
- 电压/Voltage:12V
- 排量/Displacement:138cc



KPRS113003021

- 适用车型/Applicable Vehicle: 云内D19发动机、江淮轻卡6PK 24V
- 编号/Code:KPRS-10S13
- OE:/
- 皮带轮/Pulley:PV6/128
- 电压/Voltage:24V
- 排量/Displacement:138cc



KPRS113004013

- 适用车型/Applicable Vehicle: 云内D20发动机、江淮轻卡6PK 12V
- 编号/Code:KPRS-10S13
- OE:/
- 皮带轮/Pulley:PV6/128
- 电压/Voltage:12V
- 排量/Displacement:138cc



KPRS113018007

- 适用车型/Applicable Vehicle: 陕汽商用、上汽大通、一汽青岛、成都大运、成都王牌、东方工程
- 编号/Code:KPRS-10S13
- OE:/
- 皮带轮/Pulley:PV7/119
- 电压/Voltage:24V
- 排量/Displacement:138cc



KPRS113007007

- 适用车型/Applicable Vehicle: 云内D30发动机、陕汽德龙轻卡7PK 24V
- 编号/Code:KPRS-10S13
- OE:/
- 皮带轮/Pulley:PV7/119
- 电压/Voltage:24V
- 排量/Displacement:138cc



KPRS113008008

- 适用车型/Applicable Vehicle: 东风皮卡
- 编号/Code:KPRS-10S13
- OE:/
- 皮带轮/Pulley:A2/126
- 电压/Voltage:12V
- 排量/Displacement:138cc



KPRS113007017

- 适用车型/Applicable Vehicle: 云内D30发动机
东风华神轻卡7PK 12V
- 型号/Model:KPRS-10S13
- OE:/
- 皮带轮/Pulley:PV7/119
- 电压/Voltage:12V
- 排量/Displacement:138cc



KPRS113003020

- 适用车型/Applicable Vehicle: 云内D20发动机 江淮轻卡6PK 12V
- 型号/Model: KPRS-10S13
- OE: /
- 皮带轮/Pulley: PV6/128
- 电压/Voltage: 12V
- 排量/Displacement: 138cc



KPRS113034034

- 适用车型/Applicable Vehicle: 日野卡车
- 型号/Model: KPRS-10S13
- OE: 88310-37220
- 皮带轮/Pulley: A1/133
- 电压/Voltage: 24V
- 排量/Displacement: 138cc



KPRS115001026

- 适用车型/Applicable Vehicle: 江淮轻卡6PK、24V
- 型号/Model: KPRS-10S15A
- OE: /
- 皮带轮/Pulley: PV6/128
- 电压/Voltage: 24V
- 排量/Displacement: 147cc



KPRS115002001

- 适用车型/Applicable Vehicle: 云内D20发动机、江淮轻卡6PK 12V
- 编号/Code: KPRS-10S15A
- OE: /
- 皮带轮/Pulley: PV6/128
- 电压/Voltage: 12V
- 排量/Displacement: 147cc



KPRS115002005

- 适用车型/Applicable Vehicle: 云内DEF45发动机、江淮轻卡8PK 24V
- 编号/Code: KPRS-10S15A
- OE: /
- 皮带轮/Pulley: PV8/128
- 电压/Voltage: 24V
- 排量/Displacement: 147cc



KPRS115003001

- 适用车型/Applicable Vehicle: 江铃轻卡 6PK 12V
- 编号/Code: KPRS-10S15A
- OE: /
- 皮带轮/Pulley: PV6/128
- 电压/Voltage: 12V
- 排量/Displacement: 147cc



KPRS115001024

- 适用车型/Applicable Vehicle: 云内D19发动机 江淮轻卡6PK 24V
- 型号/Model: KPRS-10S15A
- OE: /
- 皮带轮/Pulley: PV6/128
- 电压/Voltage: 24V
- 排量/Displacement: 147cc



KPRS115001002

- 适用车型/Applicable Vehicle: 江淮小轻卡、东风福瑞卡、现代泓图
- 编号/Code: KPRS-10S15A
- OE: /
- 皮带轮/Pulley: PV6/128
- 电压/Voltage: 24V
- 排量/Displacement: 147cc



KPRS115029029

- 适用车型/Applicable Vehicle: 伊朗赛帕: SP100 SHAIN PLUS
- 编号/Code: KPRS-10S15A
- OE: /
- 皮带轮/Pulley: PV4/115
- 电压/Voltage: 12V
- 排量/Displacement: 147cc



KPRS115501501

- 适用车型/Applicable Vehicle: 国四小挖机
- 编号/Code: KPRS-10PA15
- OE: /
- 皮带轮/Pulley: A1/133
- 电压/Voltage: 12V
- 排量/Displacement: 155cc



KPRS115001012

- 适用车型/Applicable Vehicle: 江淮轻卡 6PK 24V
- 型号/Model: KPRS-10S15A
- OE: /
- 皮带轮/Pulley: PV6/128
- 电压/Voltage: 12V
- 排量/Displacement: 147cc



KPRS115008008

- 适用车型/Applicable Vehicle: 云内D25发动机 7PK 24V
- 型号/Model: KPRS-FS10减排
- OE: /
- 皮带轮/Pulley: PV7/120
- 电压/Voltage: 24V
- 排量/Displacement: 145cc



KPRS115502502

- 适用车型/Applicable Vehicle: 奔驰卡车9PK
- 编号/Code: KPRS-10PA15
- OE: /
- 皮带轮/Pulley: PV9/130
- 电压/Voltage: 24V
- 排量/Displacement: 155cc



KPRS115001003

- 适用车型/Applicable Vehicle: 云内D20发动机、江淮轻卡6PK 24V
- 编号/Code: KPRS-10S15A
- 皮带轮/Pulley: PV6/128
- 电压/Voltage: 24V
- 排量/Displacement: 147cc



KPRS115001004

- 适用车型/Applicable Vehicle: 云内D20发动机、江淮轻卡6PK 24V
- 编号/Code: KPRS-10S15A
- 皮带轮/Pulley: PV6/128
- 电压/Voltage: 24V
- 排量/Displacement: 147cc



KPRS115008021

- 适用车型/Applicable Vehicle: 云内D25发动机 7PK 24V
- 型号/Model: KPRS-FS10减排
- OE: /
- 皮带轮/Pulley: PV7/120
- 电压/Voltage: 24V
- 排量/Displacement: 145cc



KPRS115504504

- 适用车型/Applicable Vehicle: 丰田 兰德酷路泽/普拉多
- 型号/Model: KPRS-10PA15
- OE: 88310-60630
- 皮带轮/Pulley: A1/143
- 电压/Voltage: 12V
- 排量/Displacement: 155cc



KPRS116501501

- 适用车型/Applicable Vehicle: 江淮4脚8pk N448卡车
- 型号/Model: KPRS-10PA15P
- OE: /
- 皮带轮/Pulley: PV8/120
- 电压/Voltage: 24V
- 排量/Displacement: 167cc



KPRS116007007

- 适用车型/Applicable Vehicle: 五十铃 6HK1 卡车
- 编号/Code:KPRS-10S15
- OE:/
- 皮带轮/Pulley:A1/133
- 电压/Voltage:24V
- 排量/Displacement:167cc



KPRS116008008

- 适用车型/Applicable Vehicle: 本田步威
- 编号/Code:KPRS-10S15
- OE:/
- 皮带轮/Pulley:PV6/115
- 电压/Voltage:/
- 排量/Displacement:167cc



KPRS116006006

- 适用车型/Applicable Vehicle: 日野卡车 700
- 编号/Code:KPRS-10S15
- OE:/
- 皮带轮/Pulley:PV5/140
- 电压/Voltage:24V
- 排量/Displacement:167cc



KPRS116001001

- 适用车型/Applicable Vehicle: 奔驰卡车8PK
- 编号/Code:KPRS-10S15
- OE:/
- 皮带轮/Pulley:PV8/140
- 电压/Voltage:24V
- 排量/Displacement:167cc



KPRS116002002

- 适用车型/Applicable Vehicle: 福莱纳卡车8PK163
- 编号/Code:KPRS-10S15
- OE:/
- 皮带轮/Pulley:PV8/163
- 电压/Voltage:12V
- 排量/Displacement:167cc



KPRS116003003

- 适用车型/Applicable Vehicle: 伊朗赛帕主机
- 编号/Code:KPRS-10S15
- OE:/
- 皮带轮/Pulley:PV6/120
- 电压/Voltage:12V
- 排量/Displacement:156cc



KPRS116009009

- 适用车型/Applicable Vehicle: 丰田RAV4
- 编号/Code:KPRS-10S15
- OE:88310-43170
- 皮带轮/Pulley:PV7/130
- 电压/Voltage:12V
- 排量/Displacement:167cc



KPRS116010010

- 适用车型/Applicable Vehicle: 吉利 远景/帝豪
- 编号/Code:KPRS-10S15
- OE:/
- 皮带轮/Pulley:PV6/125
- 电压/Voltage:12V
- 排量/Displacement:167cc



KPRS118505505

- 适用车型/Applicable Vehicle: 北汽重卡牵引1号车
- 编号/Code:KPRS-KD17
- OE:/
- 皮带轮/Pulley:PV6/119
- 电压/Voltage:24V
- 排量/Displacement:175cc



KPRS118001001

- 适用车型/Applicable Vehicle: 东风凯普特轻卡
- 编号/Code:KPRS-FS10
- OE:/
- 皮带轮/Pulley:PV7/120
- 电压/Voltage:24V
- 排量/Displacement:170.8cc



KPRS118001002

- 适用车型/Applicable Vehicle: 东风凯普特轻卡
- 编号/Code:KPRS-FS10
- OE:/
- 皮带轮/Pulley:PV7/120
- 电压/Voltage:24V
- 排量/Displacement:170.8cc



KPRS118501501

- 适用车型/Applicable Vehicle: 徐工重卡8104 潍柴13L
- 型号/Model:KPRS-KD17
- OE:/
- 皮带轮/Pulley:PV8/146
- 电压/Voltage:24V
- 排量/Displacement:175cc



KPRS118501507

- 适用车型/Applicable Vehicle: 陕汽德龙M3000
- 编号/Code:KPRS-KD17
- OE:/
- 皮带轮/Pulley:PV8/119
- 电压/Voltage:24V
- 排量/Displacement:175cc



KPRS118506506

- 适用车型/Applicable Vehicle: 二汽东风凯普斯达(凯普特NT400)
- 编号/Code:KPRS-KD17
- OE:/
- 皮带轮/Pulley:PV7/119
- 电压/Voltage:24V
- 排量/Displacement:175cc



KPRS118508508

- 适用车型/Applicable Vehicle: 东风天龙D760重卡
- 编号/Code:KPRS-KD17
- OE:/
- 皮带轮/Pulley:PV6/144
- 电压/Voltage:24V
- 排量/Displacement:175cc



KPRS118505509

- 适用车型/Applicable Vehicle: 东风纳智捷MPV大7
- 编号/Code:KPRS-KD17
- OE:/
- 皮带轮/Pulley:PV6/119
- 电压/Voltage:12V
- 排量/Displacement:175cc



KPRS118505510

- 适用车型/Applicable Vehicle: 东风纳智捷SUV
- 编号/Code:KPRS-KD17
- OE:/
- 皮带轮/Pulley:PV5/119
- 电压/Voltage:12V
- 排量/Displacement:175cc



KPRS118505511

- 适用车型/Applicable Vehicle: 陕汽重卡单A
- 编号/Code:KPRS-KD17
- OE:/
- 皮带轮/Pulley:A1/135
- 电压/Voltage:24V
- 排量/Displacement:175cc



KPRS118101001

- 适用车型/Applicable Vehicle:
山东凯马
唐骏欧铃
- 型号/Model:KPRS-FS10
- OE:/
- 皮带轮/Pulley:PV7/120
- 电压/Voltage:24V
- 排量/Displacement:170.8cc



KPRS118503503

- 适用车型/Applicable Vehicle:
北汽重卡牵引3号车
- 编号/Code:KPRS-KD17
- OE:/
- 皮带轮/Pulley:PV8/119
- 电压/Voltage:24V
- 排量/Displacement:175cc



KPRS118501502

- 适用车型/Applicable Vehicle:
大运重卡、悍威
- 编号/Code:KPRS-KD17
- OE:/
- 皮带轮/Pulley:PV6/135
- 电压/Voltage:24V
- 排量/Displacement:175cc



KPRS118504504

- 适用车型/Applicable Vehicle:
北汽重卡牵引21号车
- 型号/Model:KPRS-KD17
- OE:/
- 皮带轮/Pulley:PV5/140
- 电压/Voltage:24V
- 排量/Displacement:175cc

产品介绍

Product Introduction



大众系列

选用型号

VOLKSWAGEN SERIES SELECTION MODEL



在乎舒适、可靠、节能，就用康普瑞 & 康普瑞森压缩机



KPRS613013013

- 适用车型/Applicable Vehicle: 18款朗逸/19款速腾/帕萨特 LAVIDA 2018 SAGITAR/PASSAT 2019
- 型号/Model: KPRS-PXC14
- OE: 5QD820803J
- 皮带轮/Pulley: PV6/110
- 电压/Voltage: 12V
- 排量/Displacement: 133cc



KPRS613016016

- 适用车型/Applicable Vehicle: PX14速腾/高尔夫7/奥迪A3 PX14 Sagitar/Goif 7 /AUDI A3
- 型号/Model: KPRS-PXE14
- OE: 5Q0820803E
- 皮带轮/Pulley: PV6/110
- 电压/Voltage: 12V
- 排量/Displacement: 133cc



KPRS616002002

- 适用车型/Applicable Vehicle: 新帕萨特/速腾/迈腾 New Passat/Sagitar/Magotan
- 型号/Model: KPRS-PXE16
- OE: 1K0820803G
- 皮带轮/Pulley: PV6/110
- 电压/Voltage: 12V
- 排量/Displacement: 160cc



KPRS616102005

- 适用车型/Applicable Vehicle: 大众途昂/2.5/开迪/2.5/大众甲壳虫 VW-TOURAN/2.5/CADDY/2.5/VW BEETLE
- 型号/Model: KPRS-PXE16
- OE: 1K0820859G
- 皮带轮/Pulley: PV5/110*127
- 电压/Voltage: 12V
- 排量/Displacement: 160cc



KPRS616103003

- 适用车型/Applicable Vehicle: 大众途昂/Teramont
- 型号/Model: KPRS-PXC16
- OE: 1KD820803N
- 皮带轮/Pulley: PV6/110
- 电压/Voltage: 12V
- 排量/Displacement: 160cc



KPRS717024001

- 适用车型/Applicable Vehicle: 大众T5/VOLKSWAGEN T5
- 型号/Model: KPRS-7SE17
- OE: 7E0820803
- 皮带轮/Pulley: PV6/104
- 电压/Voltage: 12V
- 排量/Displacement: 170.5cc



KPRS717025004

- 适用车型/Applicable Vehicle: 途锐3.0/奥迪Q7 3.0 Touareg 3.0/AUDI Q7 3.0
- 型号/Model: KPRS-7SE17
- OE: 7L6820808
- 皮带轮/Pulley: PV6/110
- 电压/Voltage: 12V
- 排量/Displacement: 170.5cc



KPRS717032060

- 适用车型/Applicable Vehicle: 大众阿莫若克/VW AMAROK
- 型号/Model: KPRS-7SE17
- OE: 7E0820803F
- 皮带轮/Pulley: PV6/100
- 电压/Voltage: 12V
- 排量/Displacement: 170.5cc



KPRS716502502

- 适用车型/Applicable Vehicle: 新朗逸/13款宝来 LAVIDA 2013/BORA 2013
- 型号/Model: KPRS-7V16
- OE: /
- 皮带轮/Pulley: PV6/120
- 电压/Voltage: 12V
- 排量/Displacement: 160.5cc



KPRS716503503

- 适用车型/Applicable Vehicle:
朗逸11款/宝来08-12款
Bora 2008-2012/Lavida 2011
- 型号/Model:KPRS-7V16
- OE:1J0820803
- 皮带轮/Pulley:PV6/119
- 电压/Voltage:12V
- 排量/Displacement:160.5cc



KPRS612503503

- 适用车型/Applicable Vehicle:
12-17款桑塔纳
VOLKSWAGEN Santana 2012-2017
- 型号/Model:KPRS-6V12
- OE:/
- 皮带轮/Pulley:PV6/110
- 电压/Voltage:12V
- 排量/Displacement:125cc



KPRS613030030

- 适用车型/Applicable Vehicle:
VW AMAROK
- 型号/Model:KPRS-6SE13
- OE:2H68208034
- 皮带轮/Pulley:PV6/110
- 电压/Voltage:12V
- 排量/Displacement:133cc



KPRS717060060

- 适用车型/Applicable Vehicle:
大众皮卡
VW CRAFTER 30-35
2.0 TDI 2011-2016
- 型号/Model:KPRS-7SE17
- OE:2E0820803F
- 皮带轮/Pulley:PV6/110
- 电压/Voltage:12V
- 排量/Displacement:170.5cc



KPRS613030030

- 适用车型/Applicable Vehicle:
大众15款 迈特威
VOLKSWAGEN MULTIVAN 2015
- 型号/Model:KPRS-6SE13
- OE:447150-6890
- 皮带轮/Pulley:PV6/110
- 电压/Voltage:12V
- 排量/Displacement:170.5cc



KPRS717081039

- 适用车型/Applicable Vehicle:
19款大众CALIFORNIA2.0(1968CCM)
VW CALIFORNIA 2.0 (1968CCM)
- 型号/Model:KPRS-7SE17
- OE:7LA816803A/447140-823
- 皮带轮/Pulley:PV6/110
- 电压/Voltage:12V
- 排量/Displacement:170.5cc



KPRS717082018

- 适用车型/Applicable Vehicle:
大众17款 CRAFTER17款 MAN TGE 2.0
CRAFTER 2017/MAN TGE 2.0 2017
- 型号/Model:KPRS-6SE13
- OE:447150-6890
- 皮带轮/Pulley:PV6/110
- 电压/Voltage:12V
- 排量/Displacement:170.5cc

产品介绍

Product Introduction



在乎舒适、可靠、节能，就用康普瑞 & 康普瑞森压缩机

五菱系列 选用型号

WULING SERIES SELECTION MODEL



KPR-9607

- 适用车型/Applications: 通用五菱N200 SAIC-GM-WULING N200
- OE: /
- 皮带轮/Pulley: PV4/110
- 电压/Voltage: 12V



KPR-96113

- 适用车型/Applications: 五菱荣光1.2 WULING RONGGUANG 1.2L
- OE: /
- 皮带轮/Pulley: PV4/107
- 电压/Voltage: 12V



KPR-9616

- 适用车型/Applications: 通用五菱N200 SAIC-GM-WULING N200
- OE: /
- 皮带轮/Pulley: PV4/110
- 电压/Voltage: 12V



KPR-96161

- 适用车型/Applications: 宝骏560 2015-2017 BAOJUN 560 2015-2017
- OE: /
- 皮带轮/Pulley: PV4/110
- 电压/Voltage: 12V



KPR-9685

- 适用车型/Applications: 五菱宏光1.2 WULING HONGGUANG 1.2
- OE: /
- 皮带轮/Pulley: PV4/100
- 电压/Voltage: 12V



KPR-9687

- 适用车型/Applications: 五菱荣光1.5(替代086-AS) WULING RONGGUANG 1.5 (SUPERSEDES 086-AS)
- OE: /
- 皮带轮/Pulley: PV4/107
- 电压/Voltage: 12V



KPR-9686A

- 适用车型/Applications: 五菱宏光1.5 WULING HONGGUANGV 1.5
- OE: /
- 皮带轮/Pulley: PV6/110
- 电压/Voltage: 12V

产品介绍

Product Introduction



新能源系列

选用型号

NEW ENERGY SERIES



在乎舒适、可靠、节能，就用康普瑞森压缩机



KPRS934001010

型号/Model: K34H338-0102
适用车型/Applications:
长安星V7-CK
STAR V7-CK
电压/Voltage: DC334V
原车件号/OE: 8103 140V7001

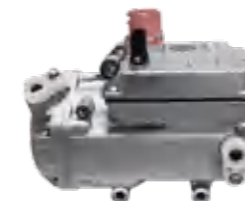

KPRS927001060

型号/Model: K27A306-0102
适用车型/Applications:
长安星V5/星V7
STAR V5/STAR V7
电压/Voltage: DC300V
原车件号/OE: CK8103 110V5009



KPRS927102102

型号/Model: K27A306-1801
适用车型/Applications:
长安新豹T3
NEW LEOPARD T3
电压/Voltage: DC300V
原车件号/OE: CK8103 110T3003



KPRS934001018

型号/Model: K34H338-0103
适用车型/Applications:
长安星光V9/星塔
STAR LIGHT V9/STAR TOWER
电压/Voltage: DC334V
原车件号/OE: CK8103 140X9001



KPRS934001019

型号/Model: K34H359-0101
适用车型/Applications:
CV01多拉大面
CV01 DUOLA DAMIAN
电压/Voltage: DC350V
原车件号/OE: CK8103 140V9007



KPRS927001084

型号/Model: K27A356-0102
适用车型/Applications:
上汽大通小福星
LITTLE LUCKY STAR
电压/Voltage: DC350V
原车件号/OE: C00591369



KPRS927005085

型号/Model: K27A566-0101
适用车型/Applications:
上汽大通小福星
LITTLE LUCKY STAR
电压/Voltage: DC560V
原车件号/OE: C00595939



KPRS934001001

型号/Model: K34H338-0101
适用车型/Applications:
威马EX5/E5/W6
WM Motor EX5/E5/W6
电压/Voltage: DC330V
原车件号/OE: VDG00240



KPRS934001005

型号/Model: K34H309-0101
适用车型/Applications:
吉利帝豪EV350/EV450 (轿车)
Geely Emgrand EV350/EV450
电压/Voltage: DC300V
原车件号/OE: EVH33Y1



KPRS927005005

型号/Model: K27C546-0101
 适用车型/Applications:
 冷藏车专用
 Refrigerated trucks
 电压/Voltage: DC540V
 原车件号/OE: /



KPRS927007052

型号/Model: K27C326-0102
 适用车型/Applications:
 冷藏车专用
 Refrigerated trucks
 电压/Voltage: DC320V
 原车件号/OE: /



KPRS933927002

型号/Model: K33C326-0101
 适用车型/Applications:
 冷藏车专用
 Refrigerated trucks
 电压/Voltage: DC320V
 原车件号/OE: /



KPRS940945508

型号/Model: K40K546-5105
 适用车型/Applications:
 3.9-5.2M冷冻冷藏车
 3.9-5.2M Refrigerated vehicle
 电压/Voltage: DC200V-750V
 原车件号/OE: /



KPRS927027182XY

型号/Model: K27A336-2401
 适用车型/Applications:
 鑫源E3
 Xinyuan E3
 电压/Voltage: DC320V
 原车件号/OE: 8103001-XA003-AA00000



KPRS933027041XY

型号/Model: K33A336-2401
 适用车型/Applications:
 鑫源E3P
 Xinyuan E3P
 电压/Voltage: DC320V
 原车件号/OE: 8103001-XA005-AA00000



KPRS933002004KLSSL

型号/Model: K33C326-0102
 适用车型/Applications:
 冷藏车专用
 Refrigerated trucks
 电压/Voltage: DC320V
 原车件号/OE: /



KPRS933005033KLSSL

型号/Model: K33C546-0101
 适用车型/Applications:
 冷藏车专用
 Refrigerated trucks
 电压/Voltage: DC540V
 原车件号/OE: /



KPRS946927510

型号/Model: K46K326-5105
 适用车型/Applications:
 冷藏车专用
 Refrigerated trucks
 电压/Voltage: DC320V
 原车件号/OE: /



KPRS927001052

型号/Model: K27C326-0102
 适用车型/Applications:
 2.1-3.1M冷冻冷藏箱车
 2.1-3.1M Refrigerated vehicle
 电压/Voltage: DC320V
 原车件号/OE: /



KPRS946945508

型号/Model: K46K546-5105
 适用车型/Applications:
 4.2-5.8M冷冻冷藏车
 4.2-5.8M Refrigerated vehicle
 电压/Voltage: DC200V-750V
 原车件号/OE: /



KPRS933945039

型号/Model: K33C546-0102
 适用车型/Applications:
 3.1-3.9M冷冻冷藏车
 3.1-3.9M Refrigerated vehicle
 电压/Voltage: DC540V
 原车件号/OE: /